



**您身边的POP专家**  
The POP Expert Besides You

**杭州富临德展示用品厂**  
Hangzhou Fulinde Displays Manufacturer

厂址：中国·杭州余杭区径山镇长乐工业区顺乐路7号  
Factory Address: No.7 Shunle Road, Changle Industrial Park,  
Jingshan Town, Yuhang, Hangzhou China 311123.

办事处：中国·杭州余杭区星桥街道星发街17号1号楼4楼  
Office Address: 4th Floor, No.17 Xingfa Road, Xingqiao Street,  
Yuhang, Hangzhou, China 311100.

电话 (Tel) : (销售部 Domestic Sales Dept) +86-571-86261878 86263789 86262338  
(外贸部 Overseas Sales Dept) +86-571-86238578 86263608 86261216

传真 (Fax) : +86-571-86161891 / 88580551

邮箱 (E-mail) : fld@fldpop.com

Http://www.fldpop.com



**您身边的POP专家**  
The POP Expert Besides You

www.fldpop.com

2018

## 公司简介

杭州富临德展示用品厂位于杭州市余杭区径山镇长乐工业区，是专业从事POP促销道具和商用陈列展示设备集研发、生产、销售于一体的现代化企业。工厂自2006年组建以来，一直努力进取、积极发展。先后引进一系列五金加工机械、注塑机、挤出机、丝网印刷机等先进设备，优化专业技术人才结构，打造一流团队，为产品自主生产化提供有力保障。目前已成为POP行业中拥有设备最先进、生产技术最尖端、产品最新、最全的生产企业之一。

富临德产品能广泛应用于国内外商超零售终端，产品主要包括：POP系列、生鲜系列、价格牌系列、货架陈列系列、百货/商场展示系列、悬挂系列，产品可涵盖卖场的整个陈列展示区域。

一路走来，在广大客户朋友的支持下，富临德产品已进入国内外多家知名大型连锁超市、商场，并建立了稳固、长久的合作关系。大部分出口产品远销东南亚、日本、韩国、澳洲、欧洲、北美等国家和地区，积累了良好的口碑和信誉。我们将继续秉承“诚信、专业、创新、拼搏”的工厂经营理念，竭力推出新产品、追求高品质，为新老客户朋友提供更好的支持、更好的服务！



## COMPANY'S PROFILE

Hangzhou Fulinde Displays Manufacturer was located in Yuhang District, Hangzhou City. Specialized in POP promotion and commercial display research, produce and sales. Since founded in 2006, the factory has been diligently enterprising, positive development. Has introduced a series of metal processing machinery, extrusion and injection molding machines, screen printing and other advanced equipment, optimize the structure of professional and technical personnel, first-class team, provide powerful guarantee for the independent production of products. Now we have the most advanced production technology equipment, the most latest and cutting-edge products manufacturing in the POP industry.

Our Products can be widely used in domestic and foreign retail terminal. Products mainly included: The POP Communications, Fresh&Chilled Merchandising, Price Ticket Merchandising, On-Shelf Merchandising, In-Store Displays, Poster Hanger Series, Products cover the stores and entire display area.

Along the way, with the support of our customers, our products has entered many well-known domestic and foreign large chain supermarkets, shopping malls, and established stable and long-term cooperation. Most of the products are exported to Southeast Asia, Japan, Korea, Australia, Europe, North America and other countries. Accumulated a good reputation and credibility from our customer. We will continue on the "Honest, Professional, Creative, Fighting." Developing the latest and high quality products, Offering the best service in return to our customers.



# DEVELOPMENT HISTORY 发展历程

杭州富临德展示用品厂  
正式成立  
Hangzhou Fulinde Displays  
Manufacturer established in 2006.



外贸部正式成立，  
开拓国际市场。  
The International Trade Dept.  
Was set up to develop Global markets.

与澳洲最大超市，  
Woolworths建立合作关系。  
Cooperated with Woolworths,  
The Largest supermarket in Australian.



与新加坡Euroswift  
建立战略合作关系。  
Established strategic cooperative relations  
with Singapore Euroswift company, the Largest  
POS Group company in Asia.



为迎合发展需要，  
公司引进了国内外  
先进技术设备。  
Introduced advanced domestic and foreign  
Technology and Equipment in order to meet  
the company's demands of development.



公司申请了各项专利，  
累计专利已达80余件。  
Successfully applied for  
more than 80 patents.



扩建现代新厂房，  
增加两条自动生产线，  
和各项设备。  
Extended our new plant and  
increased two automatic production  
lines and equipment.



Looking forward  
to the future.

引进先进的设备  
制造更好的产品

The introduction of advanced equipment  
to manufacture better products.



## Our Manufacturing

富临德全系列的注塑产品、挤塑产品、金属制品都按照最高的质量控制标准制造，并在装运前每一步都进行检查。我们的产品在材料和设计上都可以按照客户的要求定制。

FLD-The entire range of injection moulded products, extrusion moulded products, Metal products are manufactured to the highest quality control standards. We usually check every steps before shipment. Our standard products can be modified in design and materials to suit your requirements.



一个团队 一条心  
ONE TEAM ONE MIND  
一个目标 一个梦  
ONE GOAL ONE DREAM



## 回顾 Review

## Prospect 展望

尊重每一位客户，他们的成功是我们不懈的追求。  
善待每一位员工，他们是团队不可或缺的组成部分，他们为公司为客户默默的奉献。  
信守承诺，人无信而不立，事无信而不成，这是我们一如既往的坚持和恪守。  
质量是本，它是公司发展的血液，是我们专业经验的体现和衡量标准。

欢迎您浏览富临德展示为您提供的产品目录，本目录为您呈现了全球最广泛的价格促销展示及附件的组成元素。

无论您是商场、超市、便利店、服装店或者是水果超市提升整体的促销氛围又或者是为品牌手机、电脑、食品、饮料等商品的市场推广而寻找专属的强调产品的促销道具，以我们在标价展示方面的专业知识，将您的要求从概念转化成产品，从而提供整体的店内标价营销方案。

随着创新解决方案的不断发展，新产品也一直出现，本目录也只能收集大部分的产品信息，但请您始终相信，我们的团队随时为您提供高效的服务与专业的技术支持。



# C 目录 CONTENTS

## POP系列

POP COMMUNICATIONS

落地POP架·Floor POP Stands	03
台式POP架·Table POP Stands	05
磁性POP架·Magnetic POP Stands	09
POP框及配件·POP Frames & Accessories	13
POP夹子·POP Clips	23

## 生鲜系列

FRESH & CHILLED MERCHANDISING

促销台·Promotion Display Counters	33
果蔬架·F&V Stands	43
陈列展示道具·Display Props	45
生鲜价格牌·Price Cassettes	47
木箱/编织篮·Wooden Box/Plastic Wicker Basket	53
嵌套产品箱/购物篮·Nestable Produce Crate/Shopping Basket	57
周转箱/滑板车·Circulation Box/Skateboard Carrier	59
试吃台/糖果箱·Foretaste Food Stand/Food Storage Box	61

## 价格牌系列

PRICE TICKET MERCHANDISING

手拨旋转数字价格牌·Swivel Figure Price Tickets	65
翻页价格牌·Flip Charts	67
整体挤出价格牌·Whole Extrusion Price Boards	73
价格牌支架·Price Advertising Stands	74
POP封套、保护膜·PVC Pockets、Protective Films	75



## 货架陈列系列

ON-SHELF MERCHANDISING

小分类、促销卡片及配件·Shelf Talkers	79
货架价签条·Data Strips	83
金属挂钩及配件·Metal Hooks	87
分隔板·Shelf Dividers	89
推进器·Pushers	92

## 百货、商场展示系列

IN-STORE DISPLAYS

商场多功能桌架·Multi-function Table Stand for Store	97
仓储笼·Dump Bin	99
商用展示货架·Commercial Display Shelf	100
百货、商场POP立牌·Marketing Stands	103
亚克力价签·Acryl Price Holders	105
衣架·Clothes Rack	106
收银灯、导向牌·Cashier Stands、Directions Boards	107
模特服装价格牌·Price Tags	108

## 悬挂系列

POSTER HANGER SERIES

铝合金海报框·Aluminum Snap Frame	111
铝合金悬挂系统·Aluminum Poster Hangers	113
海报杆·Poster Profiles	115

# POP系列

POP COMMUNICATIONS



POP产品是一种便捷、快速、高效的广告促销用品。

POP产品适用于超市卖场、百货商场、专卖店、展览中心等各个区域；主要作用于商品的价格、功能及促销信息的传递，刺激引导消费，活跃卖场气氛。

POP products –easy, fast and efficient for promotion POP products are used for supermarkets, stores, shopping malls, a good way of promotion , guide consumption, active store atmosphere.



- 落地POP架 Floor POP Stands
- 台式POP架 Table POP Stands
- 磁性POP架 Magnetic POP Stands
- POP框及配件 POP Frames & Accessories
- POP夹子 POP Clips

Popular products

落地POP架  
Floor POP Stands

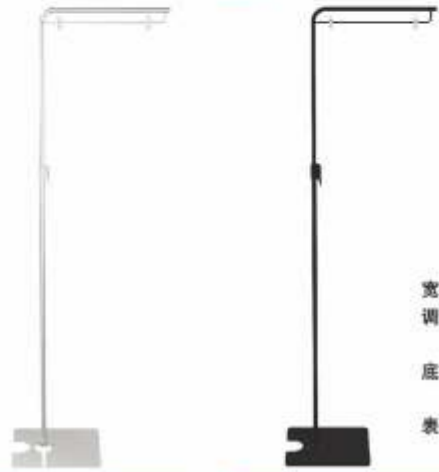

宽度 (Width) : 390mm  
 调节高度 (Adjustable Height) : A 1050-2100mm  
 B 1250-2400mm  
 底盘尺寸 (Base Size) : A 310x250x2mm  
 B 340x280x2mm  
 表面处理 (Surface Finished) : 镀铬 (Plated Chrome)  
 黑色喷塑 (Powder coated black)

Item No.: FLD-L1

Item No.: FLD-L2



FLD-L8

调节高度 (Adjustable Height) : 700-1300mm  
 底盘尺寸 (Base Size) :  $\Phi 270 \times 2 \text{mm}$   
 多功能展示框 (Multi-function Display Frame) : 210x297mm  
 表面处理 (Surface Finished) : 镀铬 (Plated Chrome)

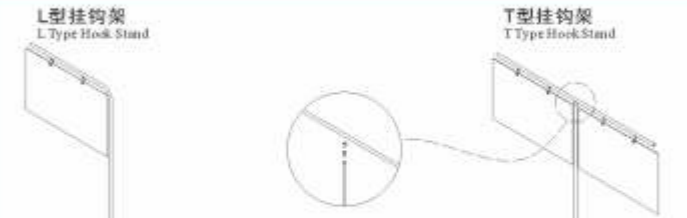

调节高度 (Adjustable Height) : 1050-2100mm  
 底盘尺寸 (Base Size) : 340x280x2mm  
 表面处理 (Surface Finished) : 镀铬 (Plated Chrome)

FLD-L20

FLD-L21

NEW

落地POP架  
Floor POP Stands



型号 (Item No.): FLD-L3

宽度 (Width) : 750mm  
 调节高度 (Adjustable Height) : 1050-2100mm  
 底盘尺寸 (Base Size) : 340x280x2mm  
 表面处理 (Surface Finished) : 镀铬 (Plated Chrome)

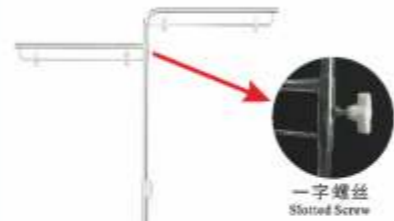

型号 (Item No.): FLD-L5

宽度 (Width) : L390mm R390mm  
 调节高度 (Adjustable Height) : A 1050-2100mm  
 B 1250-2400mm  
 底盘尺寸 (Base Size) : A 310x250x2mm  
 B 340x280x2mm  
 表面处理 (Surface Finished) : 镀铬 (Plated Chrome)



型号 (Item No.): FLD-L6

调节高度 (Adjustable Height) : A 1050-1500mm  
 B 1250-1800mm  
 底盘尺寸 (Base Size) : A 310x250x2mm  
 B 340x280x2mm  
 塑料框尺寸 (Plastic frame size) : A3 A4  
 表面处理 (Surface Finished) : 镀铬 (Plated Chrome)

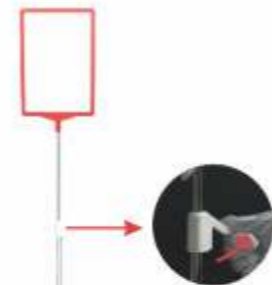

型号 (Item No.): FLD-L7

调节高度 (Adjustable Height) : 1050-1500mm  
 底盘尺寸 (Base Size) :  $\Phi 270 \times 2 \text{mm}$   
 塑料框尺寸 (Plastic frame size) : A3 A4  
 表面处理 (Surface Finished) : 镀铬 (Plated Chrome)

NEW



FLD-L9

FLD-L10



FLD-L11



FLD-L12



调节高度 (Adjustable Height) : A 1050-2100mm  
 B 1250-2400mm  
 底盘尺寸 (Base Size) : A 310x250x2mm  
 B 340x280x2mm  
 表面处理 (Surface Finished) : 镀铬 (Plated Chrome)

可配底盘 Base accessories



底盘尺寸 (Base Size): A 310x250x2mm  
 B 340x280x2mm



底盘尺寸 (Base Size):  $\Phi 230 \text{mm}$   $\Phi 270 \text{mm}$   $\Phi 320 \text{mm}$

全式POP架  
Metal POP Stands

全式POP架  
Metal POP Stands



**型号 (Item No.): FLD-T5**  
 宽度 (Width) : 250mm  
 调节高度 (Adjustable Height) : A 300-500mm  
 B 400-750mm  
 底盘尺寸 (Base Size) : 135x135x1.2mm  
 表面处理 (Surface Finished) : 镀铬 (Plated Chrome)



**型号 (Item No.): FLD-T5-2**  
 宽度 (Width) : 300mm  
 调节高度 (Adjustable Height) : A 300-500mm  
 B 400-750mm  
 底盘尺寸 (Base Size) : 135x135x1.2mm  
 表面处理 (Surface Finished) : 镀铬 (Plated Chrome)



**型号 (Item No.): FLD-T12**  
 宽度 (Width) : 250mm  
 调节高度 (Adjustable Height) : 220-800mm  
 配件 (Accessory) : 大拇指夹 (Thumb clip)



**型号 (Item No.): FLD-T13**  
 宽度 (Width) : 250mm  
 调节高度 (Adjustable Height) : A:300-500mm  
 B:400-750mm  
 表面处理 (Surface Finished) : 镀铬 (Plated Chrome)  
 塑料底盘尺寸 (Plastic Base Size) : 150x110mm



**型号 (Item No.): FLD-T6**  
 宽度 (Width) : 250mm  
 调节高度 (Adjustable Height) : A 300-500mm  
 B 400-750mm  
 底盘尺寸 (Base Size) :  $\Phi$ 160x1.2mm  
 表面处理 (Surface Finished) : 镀铬 (Plated Chrome)



**型号 (Item No.): FLD-T6-2**  
 宽度 (Width) : 300mm  
 调节高度 (Adjustable Height) : A 300-500mm  
 B 400-750mm  
 底盘尺寸 (Base Size) :  $\Phi$ 160x1.2mm  
 表面处理 (Surface Finished) : 镀铬 (Plated Chrome)



**型号 (Item No.): FLD-T15**  
 横夹尺寸 (Sidelong clip) : W80xH27mm  
 最厚可夹 (Clip thickness max) : 5mm  
 调节高度 (Adjustable Height) : A 300-500mm  
 B 400-750mm  
 底盘尺寸 (Base Size) : 135x135x1.2mm  
 表面处理 (Surface Finished) : 镀铬 (Plated Chrome)



**型号 (Item No.): FLD-T16**  
 横夹尺寸 (Sidelong clip) : W88xH20mm  
 最厚可夹 (Clip thickness max) : 3mm  
 调节高度 (Adjustable Height) : A 300-500mm  
 B 400-750mm  
 底盘尺寸 (Base Size) : 135x135x1.2mm  
 表面处理 (Surface Finished) : 镀铬 (Plated Chrome)



**型号 (Item No.): FLD-T9**  
 宽度 (Width) : 250mm  
 调节高度 (Adjustable Height) : A 300-500mm  
 B 400-750mm  
 底盘尺寸 (Base Size) : 135x135x1.2mm  
 表面处理 (Surface Finished) : 喷漆 (黑色) (Powder Coated Black)



**型号 (Item No.): FLD-T11**  
 宽度 (Width) : 250mm  
 调节高度 (Adjustable Height) : A 220-800mm  
 底盘尺寸 (Base Size) : 135x135x1.2mm  
 表面处理 (Surface Finished) : 镀铬 (Plated Chrome)



**型号 (Item No.): FLD-T17**  
 调节高度 (Adjustable Height) : A 300-500mm  
 B 400-750mm  
 上管直径 (Upper tube diameter) : 5mm  
 下管直径 (Bottom tube diameter) : 16mm  
 底盘尺寸 (Base Size) :  $\Phi$ 150x3mm  
 产品用途 (Product Usage) : 适用于箱包挂架 (Suit for hanging bags)



**型号 (Item No.): FLD-T18**  
 调节高度 (Adjustable Height) : 300-500mm  
 上管直径 (Upper tube diameter) : 9.4mm (铝 Aluminum)  
 下管直径 (Bottom tube diameter) : 12mm (铝 Aluminum)  
 底盘尺寸 (Base Size) : 180x160x1mm (不锈钢 Stainless steel)



Item No.: FLD-T10



Item No.: FLD-T10-2

宽度 (Width) : 250mm  
 调节高度 (Adjustable Height) : A 300-500mm  
 B 400-750mm  
 底盘尺寸 (Base Size) : 135x135x1.2mm  
 表面处理 (Surface Finished) : 镀铬 (Plated Chrome)



**型号 (Item No.): FLD-T18-1**  
 调节高度 (Adjustable Height) : 300-500mm  
 上管直径 (Upper tube diameter) : 9.4mm (铝 Aluminum)  
 下管直径 (Bottom tube diameter) : 12mm (铝 Aluminum)  
 底盘尺寸 (Base Size) : 180x160x1mm (黑色 Black)



**型号 (Item No.): FLD-T18-2**  
 调节高度 (Adjustable Height) : 300-500mm  
 上管直径 (Upper tube diameter) : 9.4mm (铁 iron)  
 下管直径 (Bottom tube diameter) : 12mm (铁 iron)  
 底盘尺寸 (Base Size) : 180x160x1mm (不锈钢 Stainless steel)





**型号(Item No.): FLD-T19**  
 调节高度 (Adjustable Height) : 300-500mm  
 上管直径 (Upper tube diameter) : 5mm (镀铬Plated chrome)  
 下管直径 (Bottom tube diameter) : 8mm  
 (不锈钢Stainless steel/白色喷塑 Powder coated white)  
 底盘尺寸 (Base Size) : 135x135x1mm  
 (不锈钢Stainless steel/白色喷塑 Powder coated white)  
 配件 (Accessory) : 182x128mm(B6框 Frame)



**型号(Item No.): FLD-T22**  
 调节高度 (Adjustable Height) : 300-500mm  
 上管直径 (Upper tube diameter) :  $\Phi$ 5mm (镀铬Plated chrome)  
 下管直径 (Bottom tube diameter) :  $\Phi$ 8mm  
 (不锈钢Stainless steel/白色喷塑 Powder coated white)  
 底盘尺寸 (Base Size) : 135x135x1mm  
 (不锈钢Stainless steel/白色喷塑 Powder coated white)



**型号(Item No.): FLD-T23**  
 调节高度 (Adjustable Height) : 300-500mm  
 上管直径 (Upper tube diameter) :  $\Phi$ 5mm (镀铬Plated chrome)  
 下管直径 (Bottom tube diameter) :  $\Phi$ 8mm  
 (不锈钢Stainless steel/白色喷塑 Powder coated white)  
 底盘尺寸 (Base Size) : 135x135x1mm  
 (不锈钢Stainless steel/白色喷塑 Powder coated white)



**型号(Item No.): FLD-T25**  
 调节高度 (Adjustable Height) : 330-510mm  
 上管直径 (Upper tube diameter) :  $\Phi$ 9.4mm (铝 Aluminum)  
 下管直径 (Bottom tube diameter) :  $\Phi$ 12mm (铝 Aluminum)  
 底盘尺寸 (Base Size) :  $\Phi$ 190x1.5mm  
 表面处理 (Surface Finished) : (镀铬Plated chrome)



**型号(Item No.): FLD-T30**  
 调节高度 (Adjustable Height) : 300-500mm  
 上管直径 (Upper tube diameter) :  $\Phi$ 5mm  
 下管直径 (Bottom tube diameter) :  $\Phi$ 8mm  
 表面处理 (Surface Finished) : 镀铬 (Plated chrome)  
 产品用途 (Product Usage) : 适用于箱包挂架 (Suit for hanging bags)



产品 (Product) : 活动展架 (Movable display stand)  
 表面处理 (Surface Finished) : 镀铬 (Plated chrome)

**型号(Item No.): FLD-T31**



**A4铁框台式架** NEW

调节高度 (Adjustable Height) : 190-360mm  
 上管直径 (Upper tube diameter) :  $\Phi$ 7mm  
 下管直径 (Bottom tube diameter) :  $\Phi$ 12mm  
 底盘尺寸 (Base Size) :  $\Phi$ 190x2mm  
 配件 (Accessory) : A4 A5铁框 (Iron Frame)  
 表面处理 (Surface Finished) : 黑色喷塑 (Powder coated black)

**型号(Item No.): FLD-T40**

我们的产品包含: 独特的设计, 快捷方便的安装, 及先进的生产方式。  
 We have rich experience in store marketing. Special & New Design, Quick & Easy Installation, Advanced mode of production.



**型号(Item No.): FLD-T32-1**  
 宽度 (Width) : 250mm  
 调节高度 (Adjustable Height) : A 300-500mm  
 B 400-750mm  
 底盘尺寸 (Base Size) : 190x100x1.5mm  
 白色喷塑 (Powder coated white)



**型号(Item No.): FLD-T32-2**  
 宽度 (Width) : 300mm  
 调节高度 (Adjustable Height) : A 300-500mm  
 B 400-750mm  
 底盘尺寸 (Base Size) : 190x100x1.5mm  
 白色喷塑 (Powder coated white)

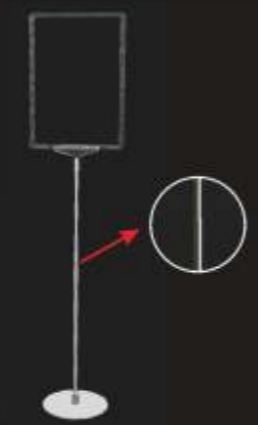

**型号(Item No.): FLD-T33** NEW  
 塑料框 (Plastic frame) : A5  
 调节高度 (Adjustable Height) : 330-510mm  
 上管直径 (Upper tube diameter) :  $\Phi$ 9.4mm  
 下管直径 (Bottom tube diameter) :  $\Phi$ 12mm  
 底盘尺寸 (Base Size) :  $\Phi$ 160x3mm  
 电杆材料 (Material of pole) : 伸缩天线 (不锈钢) Telescopic antenna (Stainless steel)



**型号(Item No.): FLD-T34** NEW  
 宽度 (Width) : 250mm  
 调节高度 (Adjustable Height) : 220-800mm  
 塑料底盘尺寸 (Plastic Base Size) :  $\Phi$ 140x4mm  
 电杆材料 (Material of pole) : 伸缩天线 (不锈钢) Telescopic antenna (Stainless steel)

可配底盘 Base accessories

 135x135x1.2mm	 135x135x1.5mm	 180x180x2mm
 $\Phi$ 160x1.2mm	 $\Phi$ 190mm $\Phi$ 200mm	 190x100x1.5mm
		 塑料底座 (Plastic Base) $\Phi$ 160x3mm





**型号(Item No.): FLD-C1**  
 宽度(Width) : 250mm  
 调节高度(Adjustable Height) : A 300-500mm  
 B 400-750mm  
 表面处理(Surface Finished) : 镀铬(Plated Chrome)



**型号(Item No.): FLD-C2**  
 宽度(Width) : 300mm  
 调节高度(Adjustable Height) : A 300-500mm  
 B 400-750mm  
 表面处理(Surface Finished) : 镀铬(Plated Chrome)



**型号(Item No.): FLD-C5**  
 宽度(Width) : 250mm  
 高度(Height) : 400mm  
 表面处理(Surface Finished) : 镀铬(Plated Chrome)



**型号(Item No.): FLD-C6**  
 宽度(Width) : 300mm  
 高度(Height) : 420mm  
 表面处理(Surface Finished) : 镀铬(Plated Chrome)



**型号(Item No.): FLD-C7**  
 高度(Height) : 150mm  
 横夹尺寸(Sidelong Clip) : W80 mm



**型号(Item No.): FLD-C8**  
 宽度(Width) : 300mm  
 高度(Height) : 100mm  
 表面处理(Surface Finished) : 镀铬(Plated Chrome)



**型号(Item No.): FLD-C9**  
 宽度(Width) : 300mm  
 表面处理(Surface Finished) : 镀铬(Plated Chrome)



**型号(Item No.): FLD-C10**  
 宽度(Width) : 250mm  
 调节高度(Adjustable Height) : 220-800mm  
 电杆材料(Material of pole) : 伸缩天线 (不锈钢)  
 Telescopic antenna(Stainless steel)



**型号 (Item No.): FLD-C13**  
 宽度(Width of transparent clip) : 70mm  
 可夹厚度(Clip thickness) : 1-8mm



**型号 (Item No.): FLD-C14**  
 宽度(Width of transparent clip) : 27mm  
 可夹厚度(Clip thickness) : 1-8mm



**型号 (Item No.): FLD-C15**  
 宽度(Width of transparent clip) : 29mm  
 可夹厚度(Clip thickness) : 1-8mm



**型号 (Item No.): FLD-C16**  
 高度(Height) : 150mm  
 透明夹宽(Width of transparent clip) : 88mm  
 可夹厚度(Clip thickness) : 3mm



**型号 (Item No.): FLD-C17**  
 高度(Height) : 可定制(Can Be Customized)  
 夹子宽度(Clip Width) : 108mm



**型号 (Item No.): FLD-C18**  
 调节高度(Adjustable Height) : 300-500mm  
 上管直径(Upper tube diameter) : 9.4mm(铝 Aluminum)  
 下管直径(Bottom tube diameter) : 12mm(铝 Aluminum)  
 可配框(Suit for Frame) : A3 A4 A5 A6



**型号 (Item No.): FLD-C20**  
 调节高度(Adjustable Height) : 300-500mm  
 上管直径(Upper tube diameter) : 9mm(铝 aluminum)  
 下管直径(Bottom tube diameter) : 12mm(铝 aluminum)



磁性POP架  
Magnetic POP Stands



**型号 (Item No.): FLD-C21**  
 调节高度 (Adjustable Height) : 180-330mm  
 上管直径 (Upper tube diameter) : 5mm  
 下管直径 (Bottom tube diameter) : 8mm



**型号 (Item No.): FLD-C22**  
 夹子宽度 (Clip Width) : 40mm  
 磁性底座尺寸 (Magnetic Base Size) : 49x49x17mm



可夹厚度 (Max Thickness) : 16mm  
 磁性底座尺寸 (Base Size) : 68x37x16mm  
**型号 (Item No.): FLD-C23**



**型号 (Item No.): FLD-C24**  
 磁性底座直径 (Magnetic Base Diameter) :  $\Phi 25$   $\Phi 36$   $\Phi 47$   $\Phi 57$ mm  
 总高 (Overall Height) : 55mm

磁性POP架  
Magnetic POP Stands

磁性底座 Magnetic base



C001



C002



C003



C004



C005



C006



C007



磁性底座



C008

型号 (Item No.)	尺寸 (Size)	适用直径 (Suit for diameter)
C001	60x39x16mm	$\Phi 5$ mm $\Phi 8$ mm $\Phi 9$ mm
C002	70x39x16mm	$\Phi 8$ mm $\Phi 9$ mm $\Phi 12$ mm
C003	48x41x16mm	$\Phi 5$ mm $\Phi 8$ mm
C004	48x49x16mm	$\Phi 8$ mm
C005	60x40x20mm	$\Phi 9$ mm $\Phi 12$ mm
C006	60x40x20mm	$\Phi 9$ mm $\Phi 12$ mm
C007	79x38x71mm	$\Phi 5$ mm $\Phi 8$ mm $\Phi 9$ mm $\Phi 12$ mm
C008	70x39x16mm	$\Phi 5$ mm $\Phi 8$ mm $\Phi 9$ mm



**型号 (Item No.): FLD-C30**



**型号 (Item No.): FLD-C25**  
 磁性底座直径 (Magnetic Base Diameter) :  $\Phi 30$ mm



**型号 (Item No.): FLD-C26**  
 磁性底座直径 (Magnetic Base Diameter) :  $\Phi 30$ mm



**型号 (Item No.): FLD-C27**  
 调节高度 (Adjustable Height) : 500-700mm  
 上管直径 (Upper tube diameter) :  $\Phi 9$ mm (铝 aluminum)  
 下管直径 (Bottom tube diameter) :  $\Phi 12$ mm (铝 aluminum)



**型号 (Item No.): FLD-C28**  
 调节高度 (Adjustable Height) : 500-700mm  
 上管直径 (Upper tube diameter) :  $\Phi 9$ mm (铝 Aluminum)  
 下管直径 (Bottom tube diameter) :  $\Phi 12$ mm (铝 Aluminum)

# Frame

Choose the frames from our standard and special size, better choices, better display products.

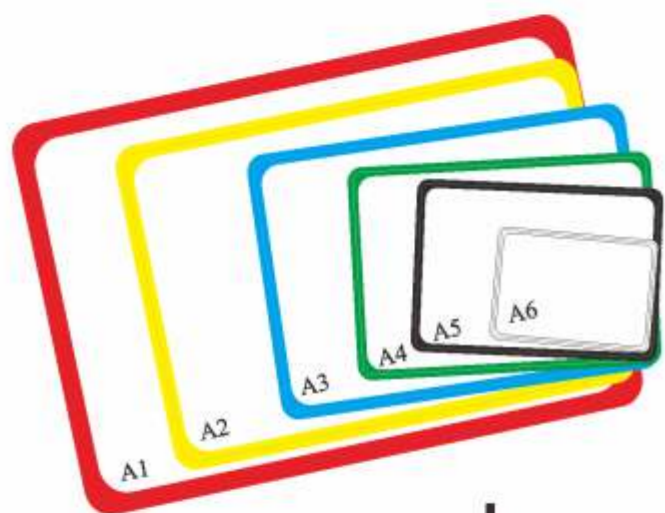

由耐用塑料材料制成;  
能够简单快速的更换海报;  
塑料框能配合使用我们各式各样的配件, 适用于各种场合;  
灵活多变的标牌体系, 尺寸A1到A6;  
支持透明和各种标准颜色的定制。

- ★ Made of durable plastic material (ABS);
- ★ Allow for a quick and easy poster change;
- ★ Using our vast range of accessories, the Frames can be used in countless applications;
- ★ Flexible and versatile Signage Systems in sizes A1 to A6;
- ★ Available in Clear and Standard Colours.

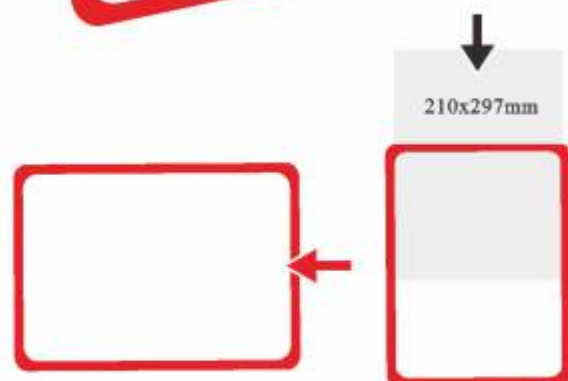

型号 (Item No.): FLD-K1

框 (Frame)	PVC尺寸 (Insert PVC Size)	材质 (Material)	颜色 (Color)
A1	840x594mm	ABS	红、黄、蓝、绿、黑、白、透明 Red, Yellow, Blue, Green, Black, White, Transparent
A2	594x420mm		
A3	420x297mm		
A4	297x210mm		
A5	210x148mm		
A6	148x105mm		

POP框及配件  
POP Frames & Accessories

POP框及配件  
POP Frames & Accessories

型号 (Item No.): FLD-K1-2

框 (Frame)	PVC尺寸 (Insert PVC Size)	材质 (Material)
A1	840 x 594mm	PVC 磨砂、全透明 (Frosted, transparent)
A2	594 x 420mm	
A3	420 x 297mm	
A4	297 x 210mm	
A5	210 x 148mm	
A6	148 x 105mm	

Advertising paper

型号 (Item No.): FLD-K1-3

带磁条PVC片 (Self-Adhesive magnetic frame)	尺寸 (Size)	厚度 (Thickness)
	A3 A4 A5	0.6mm

14"x11"

型号 (Item No.): FLD-K1-1

PVC尺寸 (Insert PVC Size)	材质 (Material)	颜色 (Color)
14"x11"	ABS	黑色 Black
11"x8.5"		
11"x7"		
11"x3.5"		

Advertising paper

型号 (Item No.): FLD-K2

PVC尺寸 (Insert PVC Size)	框材质 (Frame Material)	框颜色 (Frame Color)
A3:420x297mm	铁 (Iron)	黑色 (Black)
A4:297x210mm		
A5:210x148mm		



型号(Item No.): FLD-K3

调节高度(Adjustable Height) : A 330-510mm  
B 580-1010mm  
上管直径(Upper tube diameter) : 9.4mm(铝 Aluminum)  
下管直径(Bottom tube diameter) : 12mm(铝 Aluminum)  
底盘尺寸(Base Size) : 210 × 160 × 1.5mm  
铁、喷塑(Iron, Power Coated)  
框尺寸(Frame Size) : A3 A4 A5



型号(Item No.): FLD-K3-2

调节高度(Adjustable Height) : A 330-510mm  
B 580-1010mm  
上管直径(Upper tube diameter) : 9.4mm(铝 aluminum)  
下管直径(Bottom tube diameter) : 12mm(铝 aluminum)  
底盘尺寸(Base Size) : 220 × 120 × 3mm(ABS)  
框尺寸(Frame Size) : A3 A4 A5



型号(Item No.): FLD-K8

调节高度(Adjustable Height) : A 330-510mm  
B 400-750mm  
上管直径(Upper tube diameter) : 5mm  
下管直径(Bottom tube diameter) : 8mm  
表面处理(Surface Finished) : 镀铬(Plated Chrome)  
磁性底座尺寸(Magnetic Base Size) : 60 × 39 × 16mm  
框尺寸(Frame Size) : A3 A4 A5



Φ8mm连接杆

型号(Item No.): FLD-K9

框尺寸(Frame Size) : A3 A4 A5  
磁性底座(Magnetic Base)



型号(Item No.): FLD-K4

调节高度(Adjustable Height) : A 330-510mm  
B 580-1010mm  
上管直径(Upper tube diameter) : 9.4mm(铝 Aluminum)  
下管直径(Bottom tube diameter) : 12mm(铝 Aluminum)  
底盘尺寸(Base Size) : 220 × 120 × 1.5mm  
框尺寸(Frame Size) : A4 A5



型号(Item No.): FLD-K5

调节高度(Adjustable Height) : A 330-510mm  
B 400-750mm  
上管直径(Upper tube diameter) : 5mm  
下管直径(Bottom tube diameter) : 8mm  
表面处理(Surface Finished) : 镀铬(Plated Chrome)  
底盘尺寸(Base Size) : 135 × 135 × 1.2mm  
框尺寸(Frame Size) : A3 A4 A5



型号(Item No.): FLD-K11

框尺寸(Frame Size) : A4 A5  
底盘尺寸(Base Size) : 220 × 120 × 3mm  
颜色(Color) : 红 蓝 黑 (Red Blue Black)



型号(Item No.): FLD-K6

调节高度(Adjustable Height) : A 330-510mm  
B 400-750mm  
C 580-1010mm  
上管直径(Upper tube diameter) : 12.7mm  
下管直径(Bottom tube diameter) : 16mm  
表面处理(Surface Finished) : 镀铬(Plated Chrome)  
底盘尺寸(Base Size) : 180 × 180 × 2mm  
框尺寸(Frame Size) : A3 A4 A5



型号(Item No.): FLD-K7

高度(Height) : 400mm  
管直径(Tube diameter) : 8mm  
表面处理(Surface Finished) : 黑色喷塑(Powder coated black)  
底盘尺寸(Base Size) : 135 × 135 × 1.2mm  
框尺寸(Frame Size) : A3 A4 A5



型号(Item No.): FLD-K12

框尺寸(Frame Size) : A3 A4 A5  
配件(Accessory) : 磁性底座(Magnetic base)



型号(Item No.): FLD-K13

框尺寸(Frame Size) : A4 A5  
配件(Accessory) : 塑料夹子(Thumb Clip)



**型号 (Item No.): FLD-K31**  
 调节高度 (Adjustable Height) : 300-500mm  
 上管直径 (Upper tube diameter) :  $\Phi 9.4$ mm  
 下管直径 (Bottom tube diameter) :  $\Phi 12$ mm  
 材质 (Material) : 铝 (Aluminum)



支撑件



**型号 (Item No.): FLD-K14A**  
 宽度 (Width) : 98mm  
 适用直径 (Suit for diameter) :  $\Phi 9$ mm  $\Phi 9.4$ mm  $\Phi 12$ mm  $\Phi 12.7$ mm  
 颜色 (Color) : 可定制 (Can be customized)



**型号 (Item No.): FLD-K14B**  
 宽度 (Width) : 75mm  
 适用直径 (Suit for diameter) :  $\Phi 9$ mm  $\Phi 10$ mm  
 颜色 (Color) : 可定制 (Can be customized)



**型号 (Item No.): FLD-K14C**  
 宽度 (Width) : 66mm  
 适用直径 (Suit for diameter) :  $\Phi 5$ mm  $\Phi 8$ mm  $\Phi 9$ mm  $\Phi 9.4$ mm  
 颜色 (Color) : 可定制 (Can be customized)



**型号 (Item No.): FLD-K14D**  
 宽度 (Width) : 55mm  
 适用直径 (Suit for diameter) :  $\Phi 8$ mm  $\Phi 9$ mm  
 颜色 (Color) : 透明 (Transparent)

中节



**型号 (Item No.): FLD-K15A**  
 适用直径 (Suit for diameter) :  $\Phi 9.4$ mm (上杆 Upper Pole)  $\Phi 12$ mm (下杆 Bottom Pole)



**型号 (Item No.): FLD-K15B**  
 适用直径 (Suit for diameter) :  $\Phi 9.0$ mm (上杆 Upper Pole)  $\Phi 12$ mm (下杆 Bottom Pole)



**型号 (Item No.): FLD-K15C**  
 适用直径 (Suit for diameter) :  $\Phi 5.0$ mm (上杆 Upper Pole)  $\Phi 8.0$ mm (下杆 Bottom Pole)



**型号 (Item No.): FLD-K15D**  
 适用直径 (Suit for diameter) :  $\Phi 5.0$ mm (上杆 Upper Pole)  $\Phi 8.0$ mm (下杆 Bottom Pole)



**型号 (Item No.): FLD-K15E**  
 适用直径 (Suit for diameter) :  $\Phi 12.7$ mm (上杆 Upper Pole)  $\Phi 16$ mm (下杆 Bottom Pole)



**型号 (Item No.): FLD-K15F**  
 适用直径 (Suit for diameter) :  $\Phi 12.7$ mm (上杆 Upper Pole)  $\Phi 16$ mm (下杆 Bottom Pole)



**型号 (Item No.): FLD-K15G**  
 适用直径 (Suit for diameter) :  $\Phi 9$ mm  $\Phi 9.4$ mm (上杆 Upper Pole)  $\Phi 12$ mm (下杆 Bottom Pole)



**型号 (Item No.): FLD-K15H**  
 适用直径 (Suit for diameter) :  $\Phi 9.0$ mm (上杆 Upper Pole)  $\Phi 12$ mm (下杆 Bottom Pole)



**型号 (Item No.): FLD-K15I**  
 适用直径 (Suit for diameter) :  $\Phi 9.0$ mm (上杆 Upper Pole)  $\Phi 12$ mm (下杆 Bottom Pole)



**型号 (Item No.): FLD-K15J**  
 适用直径 (Suit for diameter) :  $\Phi 9.0$ mm (上杆 Upper Pole)  $\Phi 12$ mm (下杆 Bottom Pole)

中节



**型号 (Item No.): FLD-K16A**  
 适用直径 (Suit for diameter) :  $\Phi 8$ mm



**型号 (Item No.): FLD-K16B**  
 适用直径 (Suit for diameter) :  $\Phi 12$ mm



**型号 (Item No.): FLD-K16C**  
 适用直径 (Suit for diameter) :  $\Phi 12$ mm



**型号 (Item No.): FLD-K16D**  
 适用直径 (Suit for diameter) :  $\Phi 12$ mm



**型号 (Item No.): FLD-K21A**

磁性底座尺寸 (Magnetic base Size)	总高 (Total Height)
L35xW34xH12mm	27mm

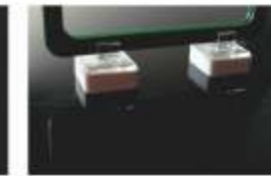

**型号 (Item No.): FLD-K21B**

磁性底座尺寸 (Magnetic base Size)	总高 (Total Height)	可旋转 (Swivel)
L38xW34xH14mm	30mm	是 (Yes)

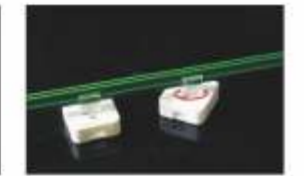

**型号 (Item No.): FLD-K21C**

磁性底座尺寸 (Magnetic base Size)	总高 (Total Height)	可旋转 (Swivel)
L38xW34xH14mm	30mm	是 (Yes)



**型号 (Item No.): FLD-K22A**

磁性底座尺寸 (Magnetic base Size)	总高 (Total Height)
L35xW34xH12mm	35mm



**型号 (Item No.): FLD-K22B**

磁性底座尺寸 (Magnetic base Size)	总高 (Total Height)
L38xW34xH14mm	38mm

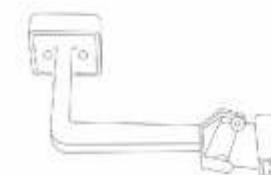

**型号 (Item No.): FLD-K23**

磁性底座尺寸 (Magnetic base Size)	长 (Length)	总高 (Total Height)
L35xW34xH12mm	115mm	70mm



### Choose your Application Frame Accessories

Using the range of accessories, our frames can be fixed in many different applications: quickly, easily and securely.

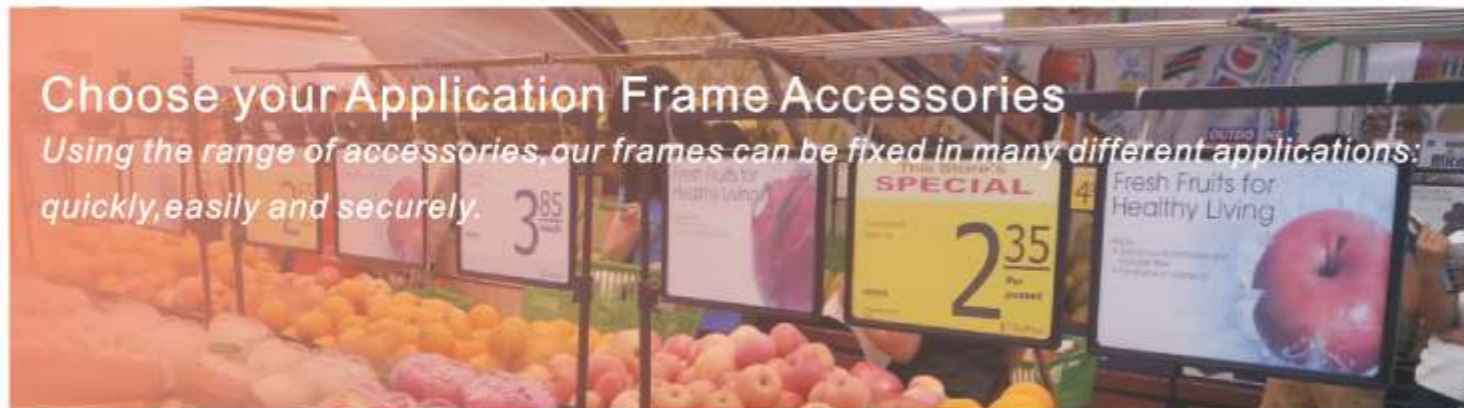

POP 框及配件  
POP Frames & Accessories

POP 框及配件  
POP Frames & Accessories



FLD-K24A



FLD-K24B



FLD-K24C



FLD-K25A

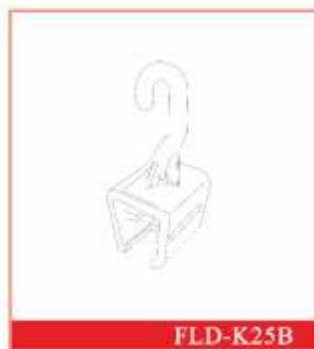

FLD-K25B



FLD-K25C



FLD-K26A



可旋轉  
Swivel

FLD-K26B



FLD-K27



Inner tube diameter  
18mm 22mm  
26mm

FLD-K28



FLD-K29



FLD-K30



黏不干胶  
Adhesive sticker

FLD-K33



150mm

FLD-K34



黏不干胶  
Adhesive sticker

FLD-K35



吸盘直径  
(Sucker diameter) :  $\Phi$ 40mm

FLD-K36



FLD-K37



FLD-K38

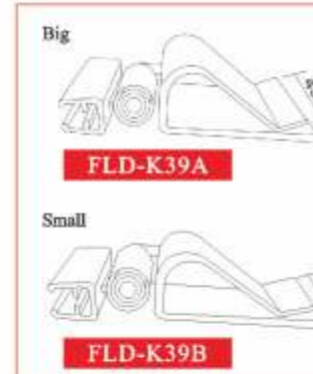

Big

FLD-K39A



Small

FLD-K39B

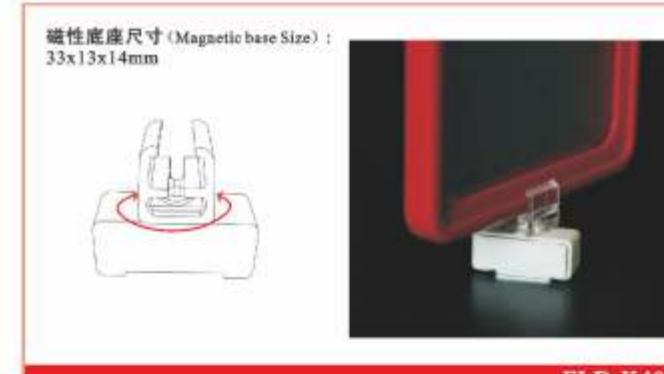

磁性底座尺寸 (Magnetic base Size) :  
33x13x14mm

FLD-K40

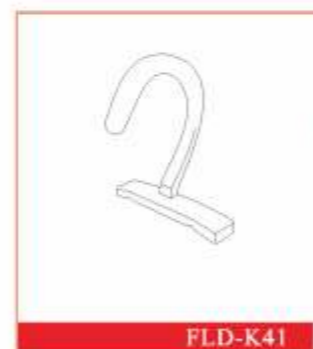

FLD-K41

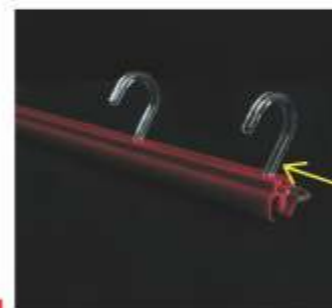

FLD-K42



NEW

Adhesive sticker

FLD-K43



FLD-K70



FLD-K71



黏不干胶  
Adhesive sticker

FLD-K72

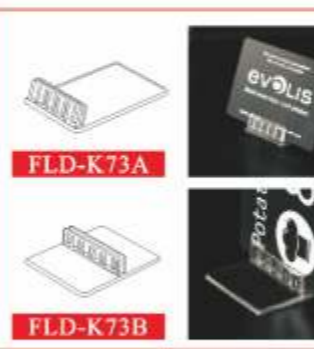

FLD-K73A

FLD-K73B



FLD-K74



FLD-K75



型号 (Item No.): FLD-K45-2

调节高度 (Adjustable Height) : A 330-510mm  
B 580-1010mm  
上管直径 (Upper tube diameter) : 9.4mm (铝 aluminum)  
下管直径 (Bottom tube diameter) : 12mm (铝 aluminum)  
底盘尺寸 (Base Size) : 210 × 160 × 1.5mm  
铁、喷漆 Powder coated (Iron)



型号 (Item No.): FLD-K45-3

调节高度 (Adjustable Height) : 330-510mm  
上管直径 (Upper tube diameter) : 9.4mm (铝 aluminum)  
下管直径 (Bottom tube diameter) : 12mm (铝 aluminum)  
可配框 (Suit for frame) : A3 A4 A5 A6  
底盘尺寸 (Base Size) : 210 × 160 × 1.5mm  
铁、喷漆 Powder coated (Iron)



型号 (Item No.): FLD-K46-1

塑料底盘 (Plastic base size) : 220 × 120 × 3mm  
底盘颜色 (Base Color) : 红、蓝、黑、白  
(Red Blue Black White)



型号 (Item No.): FLD-K46-3

调节高度 (Adjustable Height) : A 330-510mm  
B 580-1010mm  
上管直径 (Upper tube diameter) : 9.4mm (铝 aluminum)  
下管直径 (Bottom tube diameter) : 12mm (铝 aluminum)  
可配框 (Suit for frame) : A3 A4 A5 A6  
底盘尺寸 (Base Size) : 220 × 120 × 3mm (ABS)

可配底盘 Base Accessories



200 × 160 × 1.5mm



180 × 160 × 1.2mm



210 × 160 × 1.5mm



220 × 120 × 3mm

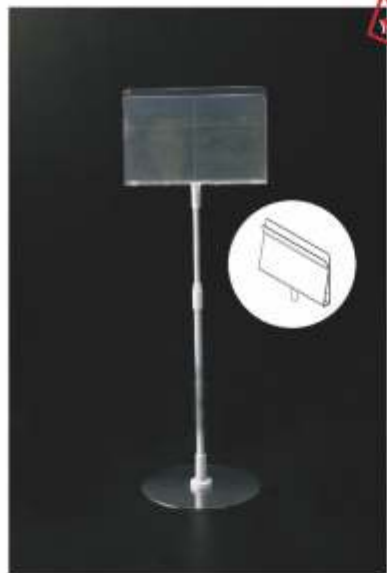

型号 (Item No.): FLD-K66

透明夹尺寸 (Transparent Clamp Size) : 216 × 140mm  
适用直径 (Suit for diameter) :  $\Phi$ 9mm  
颜色 (Color) : 透明 (Transparent)  
底盘尺寸 (Base Size) :  $\Phi$ 190mm



FLD-K49A

FLD-K49B

型号 (Item No.)	高度 (Height)	管尺寸 (Tube diameter)	磁性底座 (Magnetic base)
FLD-K49A	140mm	300 × $\Phi$ 8mm	
FLD-K49B	240mm	300 × $\Phi$ 8mm	



FLD-K50A

FLD-K50B

型号 (Item No.)	高度 (Height)	材质 (Material)	白、红、黄、蓝、黑 (White, Red, Yellow, Blue, Black)
FLD-K50A	140mm	塑料夹子 (Plastic clip)	White, Red, Yellow, Blue, Black
FLD-K50B	240mm	塑料夹子 (Plastic clip)	White, Red, Yellow, Blue, Black

透明拇指夹 Transparent thumb clip



型号 (Item No.): FLD-K51

可配框 (Suit for frame) : A4 A5 A6  
材质 (Material) : PC



型号 (Item No.): FLD-K60

可配框 (Suit for frame) : B6 (182 × 128mm)  
材质 (Material) : ABS  
管卡 (Bottom clamp grip range) :  $\Phi$ 12-25mm



型号 (Item No.): FLD-K61

材质 (Material) : 铝 (Aluminum)  
透明卡片夹 (Transparent Card Holder)

多功能展示框夹 Multi-function Display Frame

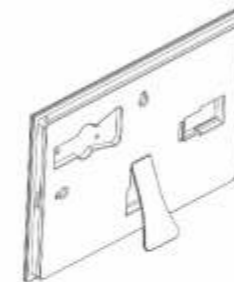

A: 摆台式 (Table top)  
Size: 297 × 210mm

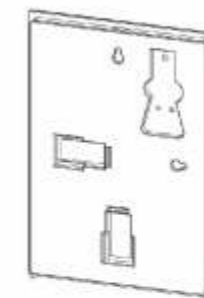

B: 悬挂式 (Wall mounted)  
Size: 210 × 297mm



型号 (Item No.): FLD-K63



POP夹子  
POP Clips

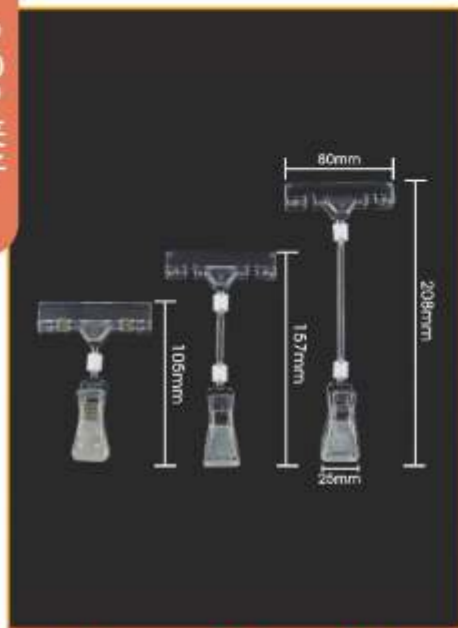

D1 D2 D3



D1-1

**用料:** 夹子采用全新的PC、PS料及不锈钢弹簧，产品晶莹剔透，结实耐用，关节处可自由调节。

**Material:** This Product Uses a new improver PC、PS material and stainless steel clamp, crystal clear,durable,joints can be adjustable.

**Application:** Supermarket、Store、Shopping mall、Excludive shop、Exhibition etc product sales occasions.



D4-1 D4-2 D4-3

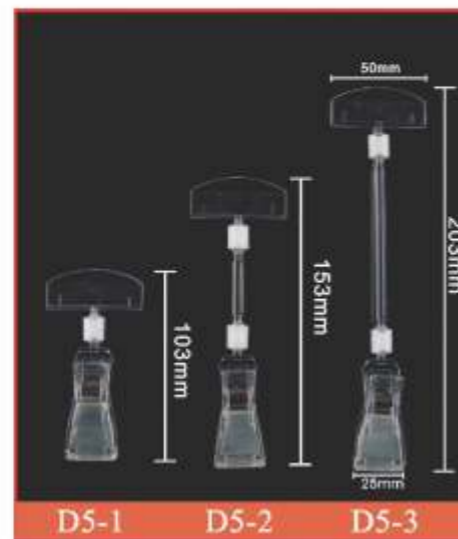

D5-1 D5-2 D5-3



D6-1 D6-2 D6-3

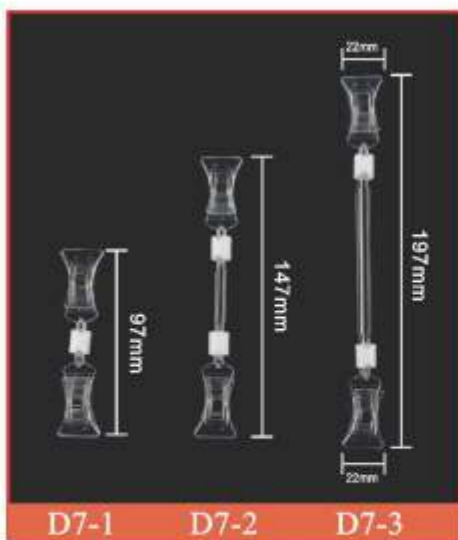

D7-1 D7-2 D7-3

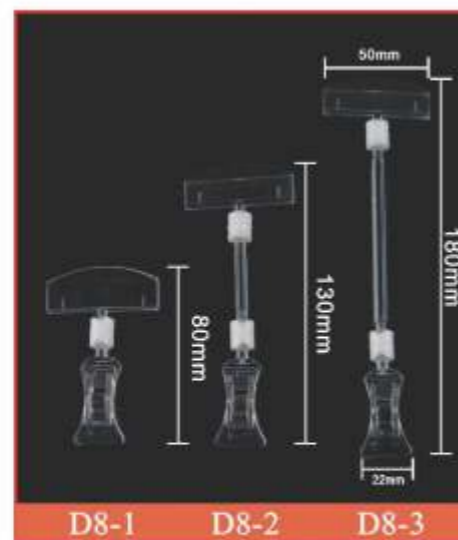

D8-1 D8-2 D8-3



D8-4 D8-5 D8-6



D9 D10



D11 D12 D13

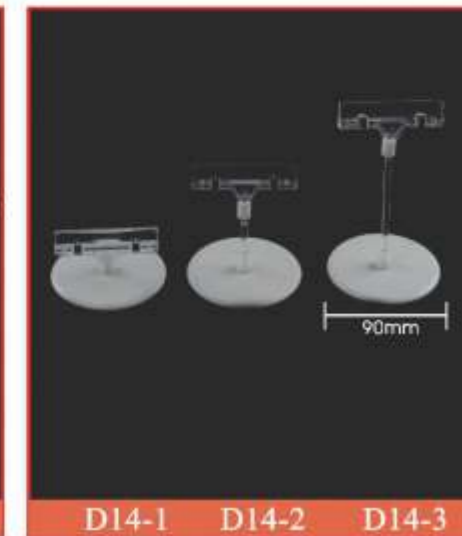

D14-1 D14-2 D14-3

POP夹子  
POP Clips

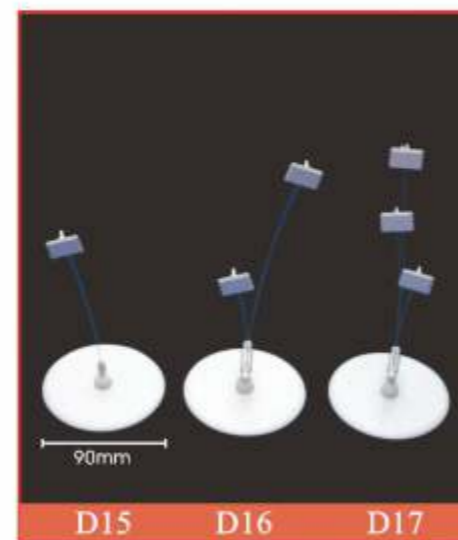

D15 D16 D17

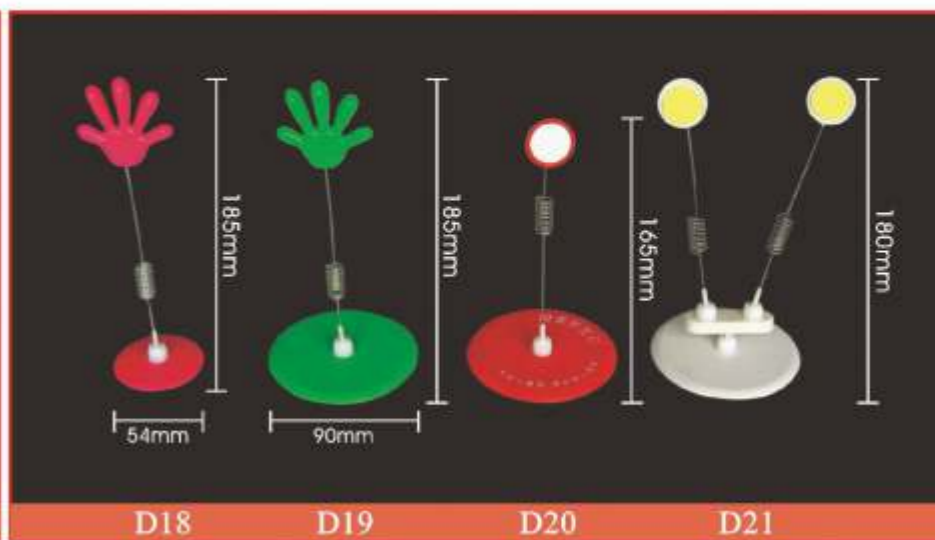

D18 D19 D20 D21

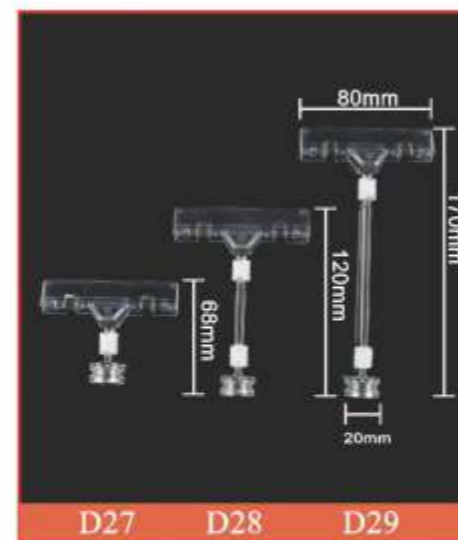

D27 D28 D29

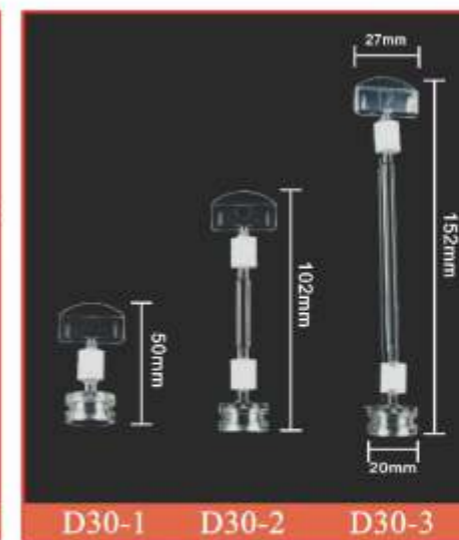

D30-1 D30-2 D30-3



D30-4 D30-5 D30-6

- 优势一
- 五色炫酷;
  - 选择属于你的绚丽色彩;
  - 采用国内优质ABS材料, 无毒、无味。

- Advantage one:
- Five Gorgeous colors;
  - Choose your own gorgeous;
  - Using domestic high-quality ABS material, nontoxic, odorless.

- 优势二
- 具有超大强力夹口;
  - 附带加厚2mm防滑海绵;
  - 精制的不锈钢强力弹簧, 用于各类木质货架、铁质货架、玻璃亚克力货架等。

- Advantage two:
- With a strong grip clip;
  - With 2mm thickness non-slip sponge;
  - Exquisite stainless steel strong spring for a variety of wooden shelves, metal shelves, glass acrylic shelves.

大拇指夹 The Thumb Clamp



型号(Item No.): FLD-D25

材质(Material) : ABS  
 夹口(Clip Opening): 上夹口(Upper) 7mm  
 下夹口(Bottom) 40mm  
 高度(Height) : 155mm  
 宽度(Width) : 108mm  
 颜色(Colors) : 白、黑、红、黄、绿  
 (White, Black, Red, Yellow, Green)



型号(Item No.): FLD-D25-2

材质(Material) : ABS  
 夹口(Clip Opening): 上夹口(Upper) 7mm  
 下夹口(Bottom) 40mm  
 高度(Height) : 250mm  
 宽度(Width) : 108mm  
 颜色(Colors) : 白、黑、红、黄、绿  
 (White, Black, Red, Yellow, Green)



可变机械夹 Variable mechanical clamp



型号(Item No.): FLD-D26

材质(Material) : ABS  
 夹口(Clip Opening): 上夹口(Upper) 7mm  
 下夹口(Bottom) 32mm  
 高度(Height) : 175mm  
 宽度(Width) : 55mm  
 颜色(Colors) : 白、黑、红、黄、绿  
 (White, Black, Red, Yellow, Green)



型号(Item No.): FLD-D26-2

材质(Material) : ABS / PC  
 夹口(Clip Opening): 上夹口(Upper) 7mm  
 下夹口(Bottom) 32mm  
 高度(Height) : 154mm  
 宽度(Width) : 73mm  
 颜色(Colors) : 透明(Transparent)



D31 D32 D33



D34-1 D34-2 D34-3



D35-1 D35-2 D35-3



D36-1 D36-2 D36-3



D37-1 D37-2 D37-3



D38-1 D38-2 D38-3



D39-1 D39-2 D39-3



D40 D41 D42



D42 D43

POP 夹子  
POP Clips

POP 夹子  
POP Clips

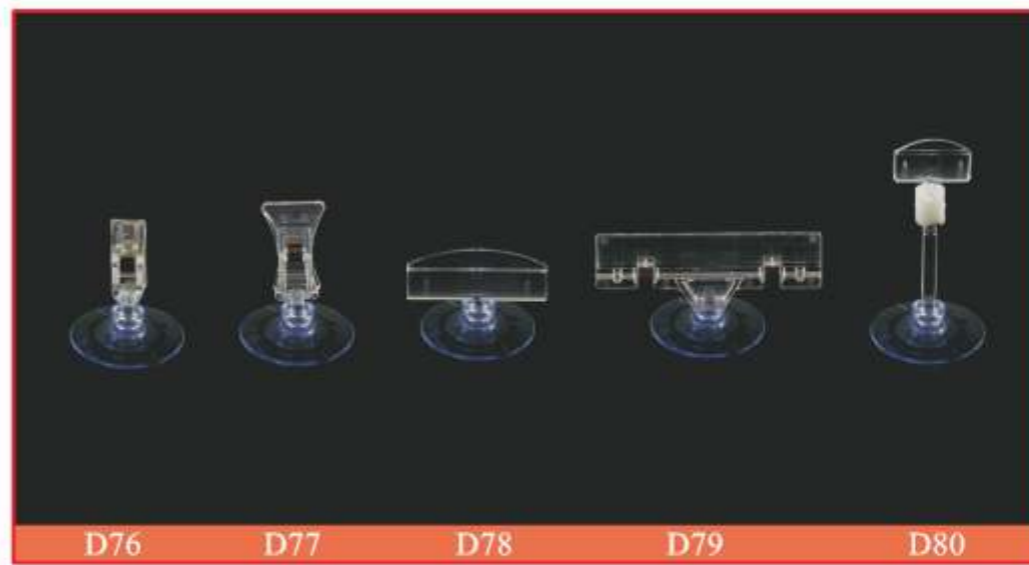
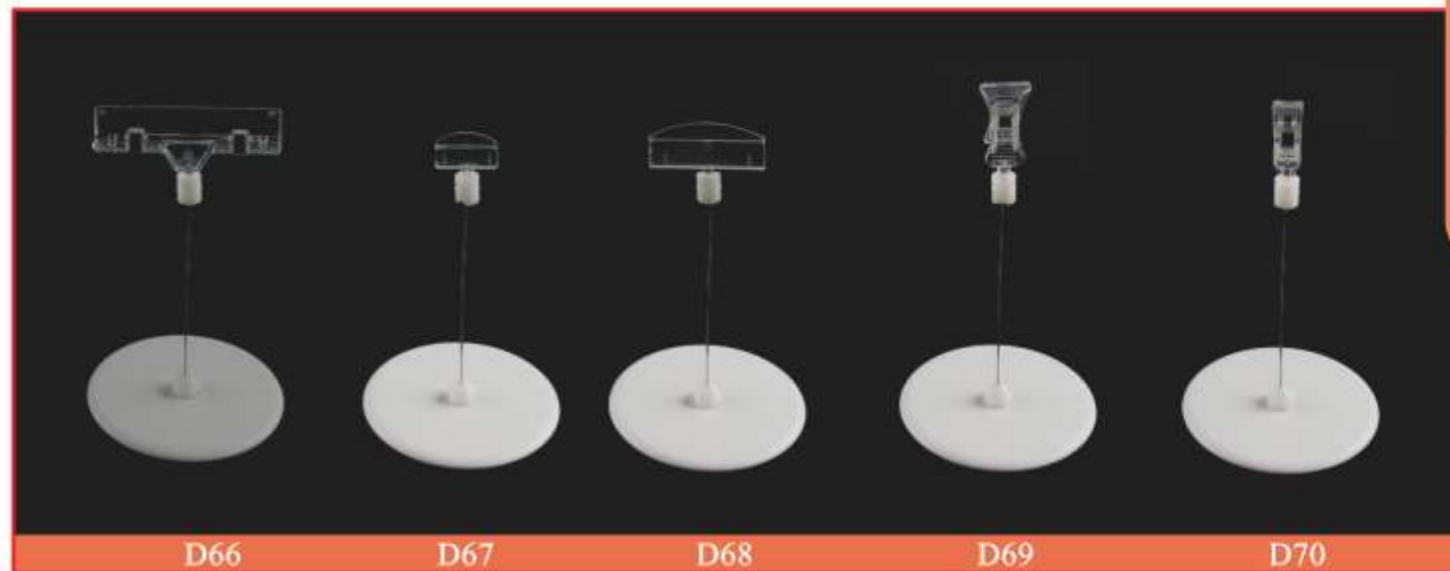
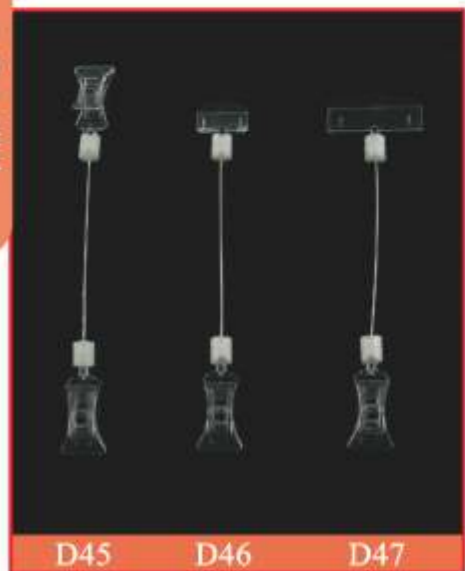

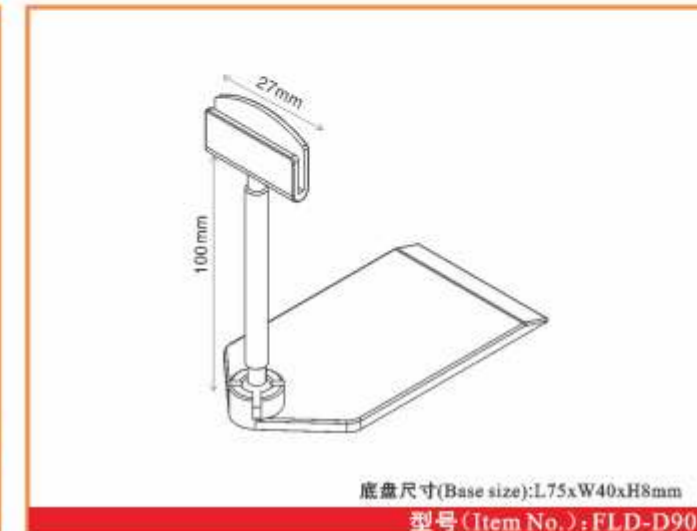

FRESH & CHILLED MERCHANDISING  
**生鲜系列**



本系列产品多用于超市生鲜区、熟食区、蔬果区商品的展示与标价，款式与材质不仅环保，而且多样化，让您的商品锦上添花。

It is mainly for the price signs of Supermarket commodities in the Fresh areas, Cooked Food areas, Vegetable and Fruit areas. Not only are the styles and materials environmental, but the variety, which promote much better.



- 促销台 Promotion Display Counters
- 果蔬架 F&V Stands
- 陈列展示道具 Display Props
- 生鲜价格牌 Price Cassettes
- 木箱 / 编织篮 Wooden Box / Plastic Wicker Basket
- 嵌套产品箱 / 购物篮 Nestable Produce Crate / Shopping Basket
- 周转箱 / 滑板车 Circulation Box / Skateboard Carrier
- 试吃台 / 糖果箱 Foretaste Food Stand / Food Storage Box

促销台轻巧便携，承重力强。除此之外，它还能折叠起来，便于存放和携带。  
可用于简单产品的补充存放，周边的围栏也可防止物品掉落。

Promo Wagon is lightweight, portable, and can with stand heavy weights. Apart from that, it can be folded for easy storage and when carrying around. Storage space available for easy product replenishment and optional perimeter fencing also available to prevent items from falling off.

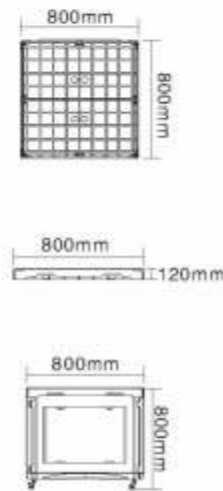

**型号(Item No.): FLD-CX8080**  
 尺寸(Size) : 800x800 mm  
 材质(Material) : 树脂(黑色) Resin(Black)  
 POP板尺寸(POP Board Size) : A2(594x420mm)  
 底部垫板(Base Pads) : 胶合板(Plywood)  
 承重(Load-bearing) : 300 kg(面板安装后)



从侧面插入 Side-Loading



可折叠、节省空间 Foldable, Space-saving



可存放商品 Storage Of Goods

- ★ 该产品适用于展示需要堆叠且不接触地面的盒装产品，使产品堆放更为稳定。
- ★ 可以连接两个或者多个来堆叠更多的产品。
- ★ 材料: PP

- ★ Useful for displaying boxed products that needed to be stacked up without touching the floor. Comes with a base for better stability.
- ★ Two or more can be connected to withstand merchandise of larger surface.
- ★ Material: PP

简易地堆 Platforms



**型号(Item No.): FLD-CX106**  
 材质(Body) : PP  
 尺寸(Size) : 400x300x120mm

展示块-正方块 Metrics Cube (Square)



**型号(Item No.): FLD-CX107**  
 材质(Body) : PP  
 尺寸(Size) : 100x100x100mm

展示块--三角 Metrics Cube(Triangle)



**型号(Item No.): FLD-CX108**  
 材质(Body) : PP  
 尺寸(Size) : 100x100x100mm



可选配件 Accessories Available

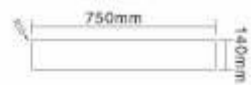
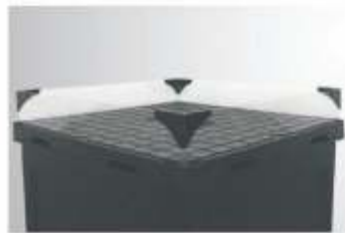

**型号(Item No.): FLD-CX01**  
 品名(Commodity) : 挡板(Stopper Guard)  
 材质(Material) : PS/亚克力(PS/Acryl)

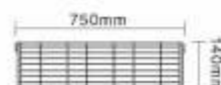

**型号(Item No.): FLD-CX02**  
 品名(Commodity) : 金属网栏(Metal Mesh Fence)  
 材质(Material) : 黑色烤漆电镀丝(Black/Chrome)



**型号(Item No.): FLD-CX03**  
 品名(Commodity) : 挡板连接器(Stopper Connector)  
 材质(Material) : 树脂(黑色) Resin(Black)



**型号(Item No.): FLD-CX04**  
 品名(Commodity) : 连接件(Connection Parts)  
 材质(Material) : 电镀(Chrome Plated Steel)

展示块--三角 Metrics Cube(Triangle)



**型号(Item No.): FLD-CX109**  
 材质(Body) : PP  
 尺寸(Size) : 100x100x100mm



**型号(Item No.): FLD-CX110**  
 材质(Body) : PP  
 尺寸(Size) : 100x100x100mm

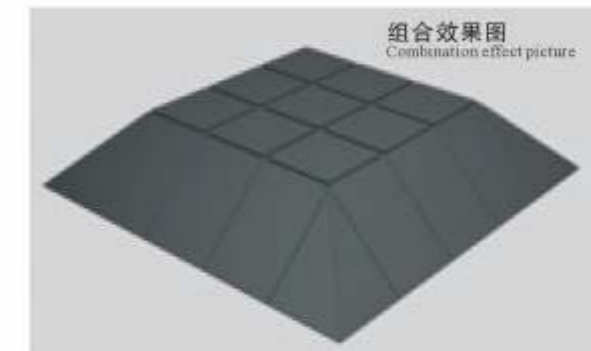

促销台  
Promotion Display Counters



**产品描述:**  
该款蔬果架的设计是为了在商店里更丰富的展示和陈列蔬果。可以通过3个不同的角度来摆放陈列商品,给顾客不同的视觉冲击。各种不同的配件可与展架完美组合匹配,展现给顾客更好的效果。

**Product Description:**  
This wagon is designed to achieve a theatrical display of the Fruit & Vegetables sections in the store. With the help of 3 different angle display option,retailer can showcase different visual impact of the merchandise. The different accessories can wellmatch the wagon display and better convey the selling message to shoppers.

型号 (Item No.): FLD-CX1300

尺寸(Size) : 1200x900 mm  
材质(Material) 主体(Body): 钢管结构(Painted Steel)  
槽板(Cross Board): ABS  
承重(Load-bearing) : 120 kg  
颜色(Color) : 可定制(Can Be Customized)



松木板  
Pine Board

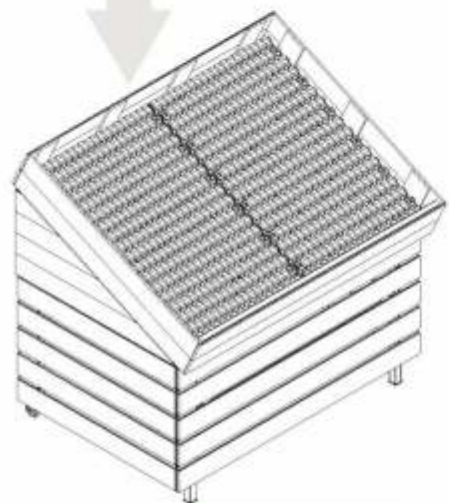

FLD-CX120120



正面  
Front View

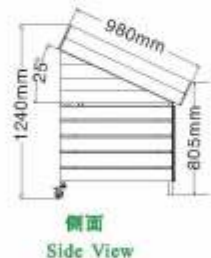

侧面  
Side View

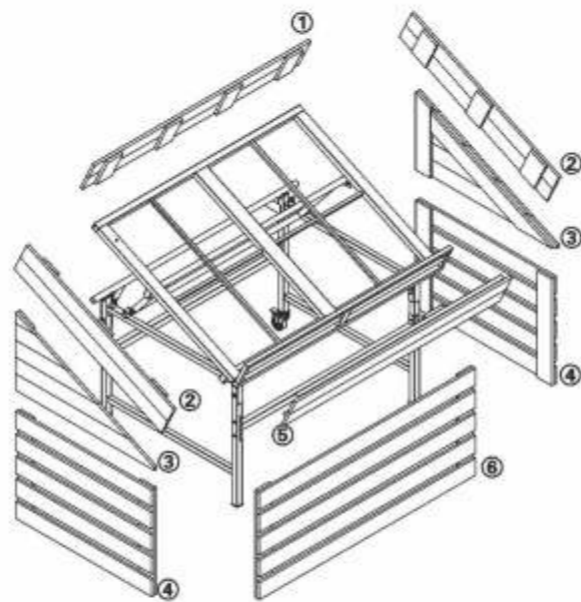
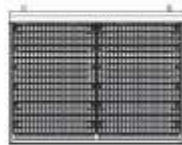

型号 (Item No.)	产品名称 (Commodity)	尺寸(Size)
1	FLD-CX120120-1a 后挡板 (Back Stopper Guard)	1260x170mm
2	FLD-CX120120-1b 侧挡板 (Side Stopper Guard)	950x170mm
3	FLD-CX120120-1c 三角板 (Triangle Side Panel)	810x410mm
4	FLD-CX120120-1d 侧板 (Side Bottom Panel)	795x540mm
5	FLD-CX120120-1e 前挡板 (Front Stopper Guard)	1260x170mm
6	FLD-CX120120-1f 前板 (Front Bottom Panel)	1260x540mm

促销台  
Promotion Display Counters

多层板 Multilayer Board

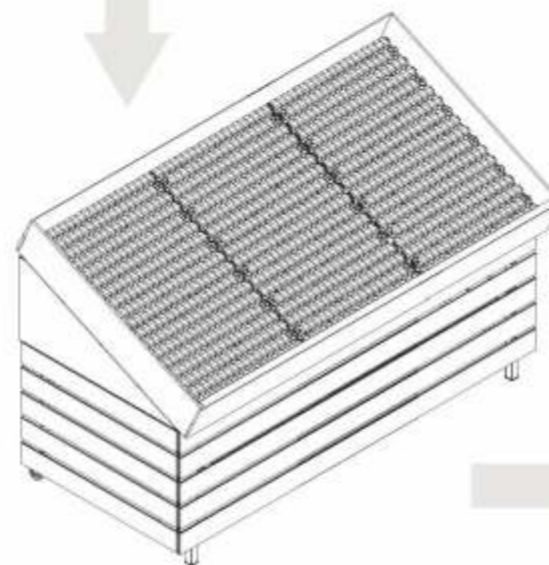

FLD-CX180180

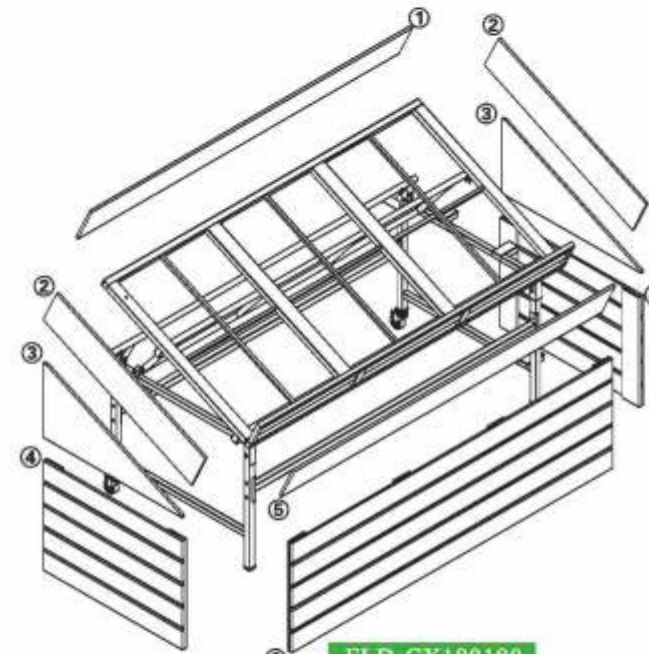

型号 (Item No.)	产品名称 (Commodity)	尺寸(Size)
1	FLD-CX180180-1a 后挡板 (Back Stopper Guard)	1830x180mm
2	FLD-CX180180-1b 侧挡板 (Side Stopper Guard)	935x180mm
3	FLD-CX180180-1c 三角板 (Triangle Side Panel)	810x410mm
4	FLD-CX180180-1d 侧板 (Side Bottom Panel)	795x540mm
5	FLD-CX180180-1e 前挡板 (Front Stopper Guard)	1830x180mm
6	FLD-CX180180-1f 前板 (Front Bottom Panel)	1830x540mm

桌面果蔬架 • FV Launcher Wagon

木制展架：  
该产品是常规可调角度展架的基础上设计而来；  
可提供不同木材材料和颜色的定制；  
可拼接成更大尺寸供生鲜展示。

Wooden wagon:  
This wagon is designed as the stand Angled wagon,  
The different kinds of wooden materials and colors can be customized,  
Connect to large size for fresh presentation.



桌面果蔬架-中岛架 FV Launcher Wagon-Island

型号 (Item No.)	产品名称 (Commodity)	尺寸 (Size)
① FLD-CX1600-1a	台面前板 (Table Front Panel)	1200x150mm
② FLD-CX1600-1b	亚克力挡板 (Acrylic Panel)	1200x205mm
③ FLD-CX1600-1c	前板 (Front Bottom Panel)	1200x720mm
④ FLD-CX1600-1d	侧板 (Side Bottom Panel)	1035x1095mm



FLD-CX1600-1

桌面果蔬架-端头架 FV Launcher Wagon-End

型号 (Item No.)	产品名称 (Commodity)	尺寸 (Size)
① FLD-CX1600-2a	侧板 (Side Bottom Panel)	1000x800mm
② FLD-CX1600-2b	背板 (Back Panel)	1880x800mm
③ FLD-CX1400-2c	木箱 (Wooden Box)	450x480mm
④ FLD-CX1400-2d	前板 (Front Bottom Panel)	1880x800mm

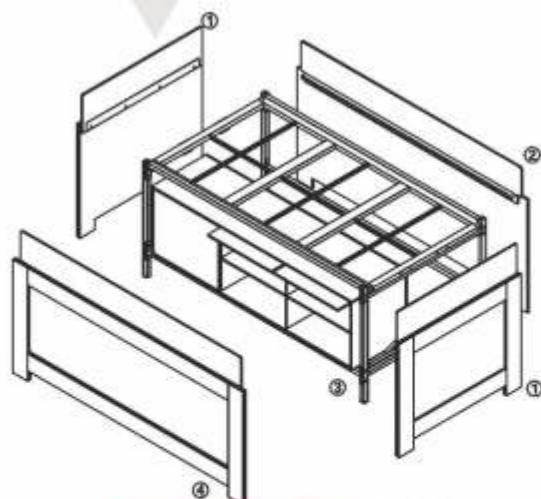

FLD-CX1600-2 材质: 多层板 Material: Multilayer Board

斜坡果蔬架 • FV Slope Wagon

此款斜坡架采用铁木结合的材质, 整体美观大方。  
新增加了两种不同角度的篮子堆放功能, 可斜着放也可以平着放, 方便客户拿取物品。  
此外架子下面还多设计了一个抽屉储物功能, 不占空间, 可用来堆放更多的物品。



This product using iron and wood combined with the material, the overall appearance.  
New added two different angles of the basket stacking function, can be tilted put or flat, Convenient customers to take products.  
In addition, The shelf below design a drawer storage function, does not occupy space, can be stacker more products.

斜坡果蔬架-中岛架 FV Slope Wagon-Island

型号 (Item No.)	产品名称 (Commodity)	尺寸 (Size)
① FLD-CX1700-1a	侧板 (Side Bottom Panel)	1155x950mm
② FLD-CX1700-1b	台面 (Table Panel)	(a) 1200x105mm (b) 1200x345mm (c) 1200x310mm (d) 1200 x 65mm (e) 1200x360mm
③ FLD-CX1700-1c	前挡板 (Front Top Panel)	1195x175mm
④ FLD-CX1700-1d	抽屉 (Drawer)	1195x795x375mm
⑤ FLD-CX1700-1e	前板 (Front Bottom Panel)	1200x365mm

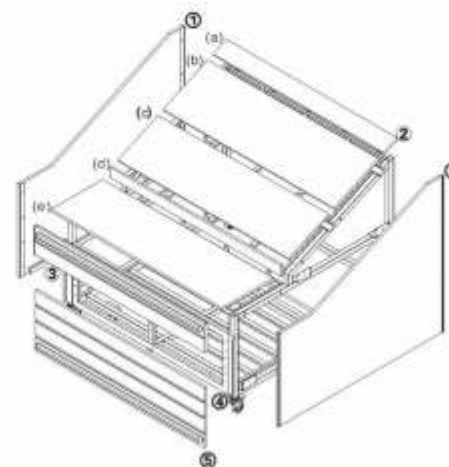

FLD-CX1700-1

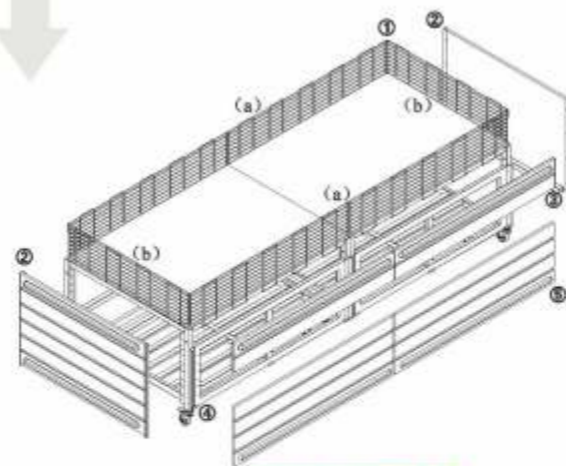

FLD-CX1700-2

斜坡果蔬架-端头架 FV Slope Wagon-End

型号 (Item No.)	产品名称 (Commodity)	尺寸 (Size)
① FLD-CX1700-2a	侧板 (Side Bottom Panel)	(a) 1135x245mm (b) 865x245mm
② FLD-CX1700-2b	侧板 (Side Bottom Panel)	895x555mm
③ FLD-CX1700-2c	前挡板 (Front Bottom Panel)	1135x175mm
④ FLD-CX1700-2d	抽屉 (Drawer)	1135x795x375mm
⑤ FLD-CX1700-2e	前板 (Front Bottom Panel)	1130x365mm





\$9.78

MANGO  
\$8.67

RED GRAPES  
\$6.99

\$6.95

\$6.15

\$4.60

\$9.99

\$6.95

\$6.15

\$4.60

\$9.99

\$11.00

\$

优势

- ★ 商品的摆放能体现出陈列设计和创新的感觉。
- ★ 配件包括可调节角度的支架分隔板和挂钩。
- ★ 有倾斜度的展示有助于使商品更靠近消费者。
- ★ “冲孔”的格栅设计便于产品清洗和维护。

Advantages

- ★ Ideal for fresh produce and loose merchandise display.
- ★ Accessories include hooks, angled shelves, and dividers.
- ★ Gradient display helps to bring the product nearer to shoppers.
- ★ Use of dummy display to reduce stock hold.
- ★ "Punch Through" design ease cleaning and maintaining of the wagon.



生鲜槽板  
Fresh Cross Board

型号(Item No.): FLD-CX100

尺寸(Size): 600x300 mm

站立式槽板  
Cross Board Stand

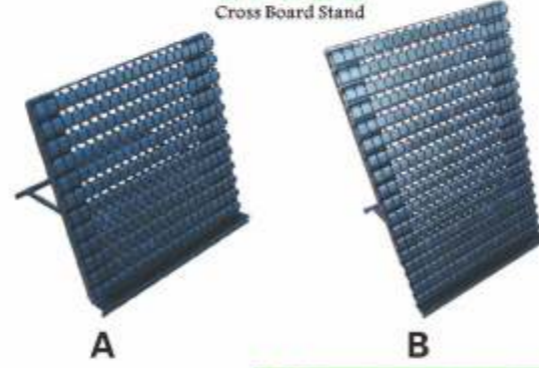

A

B

型号(Item No.): FLD-CX101

尺寸(Size): A 600x600mm  
B 600x900mm

槽板垫高台 Cross Board Riser



在生鲜槽板上作出分层或者波浪形陈列  
Used to create Tiered or Wavy display on Cross Board.



型号 (Item No.): FLD-CX102

尺寸(Size): 285x155x100mm

POP支架 POP Stand



型号 (Item No.): FLD-CX103

调节高度 (Adjustable Height): 400—750mm

POP端架 POP Support Stand



型号 (Item No.): FLD-CX105



FLD-CX121a

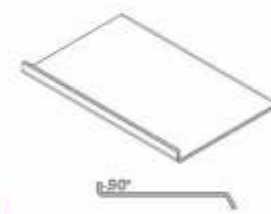

FLD-CX121b

材质 (Body): PS  
尺寸 (Size): 100x100x100mm

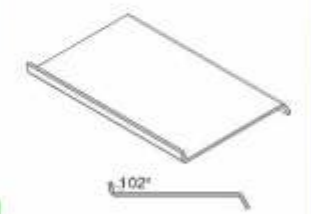

槽板篮配件 Cross Board Basket Lifting



FLD-CX130a

Description:  
Cross Board Basket Lifting D22



FLD-CX130b

Description:  
Cross Board Basket Lifting H220

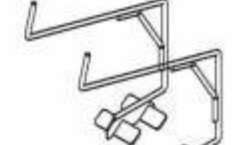

FLD-CX131

Description:  
Cross Board Basket Lifting 3 Tier

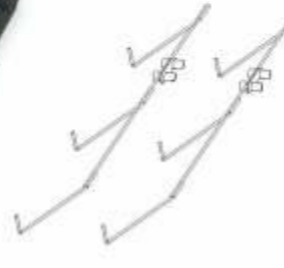

FLD-CX132

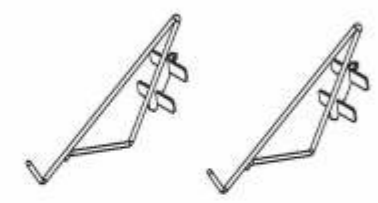

FLD-CX133

双面果蔬架 Double Layer Fruit and vegetable stand



我们的蔬果架经过精心设计，全部可拆卸，而且包装平整，便于仓储和运输。您可以添加您喜欢的配件，比如利用横板的网格做基础，在四周加上印刷版面，支撑塑料包装，价格展示牌等等，当顾客走进您商店的时候，会让顾客更想走进蔬果区。蔬果架的角度是按照亚洲人的体型来设计的，确保大部分人都能够着架子顶部。

Our carefully designed produce wagons are fully knocked-down and flat packed, which eases storage and delivery. You can add your preferred accessories like Cross/Grid Boards as base, add printed panels on the 4 sides, plastic bag holder, price card holders and many more that will help to excite your customers when they stroll into the F&V section in your retail stores. The angle of the wagon is calculated as such that most average Asian physique will be able to reach the top end of the wagon.



型号(Item No.): FLD-Q1

尺寸(Size) : 1220x1000x1120mm  
颜色(Color) : 棕色、黑色(Brown, Black)  
表面处理(Surface Finished): 喷塑(Powder Coated)

蔬果架防撞条 Bumper for Fruit and vegetable stand



● Supporting the use of Q1



型号(Item No.): FLD-Q5

尺寸(Size) : 610x49mm  
颜色(Color): 黑色(Black)



FLD-Q2A

型号(Item No.): FLD-Q2

尺寸(Size) : W530xH1300mm  
管径(Tube Diameter) : 25mm  
表面处理(Surface Finished): 黑色喷塑  
Powder Coated (Black)

L型果围栏 Fruit Fence

果园分隔栏有各种各样的颜色，用于商品类别管理和独特的分类，可以连接到所需的长度。

Work like metrics, these dividers come in various colors for category management to call out premium, or unique assortments, Inter-connectable to required lengths.



尺寸(Size) : FLD-Q3(390x200x120mm)  
FLD-Q4(200x140x120mm)

颜色(Color): 绿、黑、透明(Green, Black, Transparent)



Big



型号(Item No.): FLD-Q3



Small



型号(Item No.): FLD-Q4



万向轮

Φ10mm | 橡胶轮 Rubber Leg Castor Set



FLD-Q30

FLD-Q31

Φ50mm | 橡胶轮 Rubber Leg Castor Set



FLD-Q32

FLD-Q33

Φ48mm | 橡胶轮 Rubber Leg Castor Set



FLD-Q38

FLD-Q39

FLD-Q40

Φ65mm | 橡胶轮 Rubber Leg Castor Set



FLD-Q34

FLD-Q35

Φ70mm | 橡胶轮 Rubber Leg Castor Set



FLD-Q36

FLD-Q37

FLD-Q38



FLD-Q42



FLD-Q43

Φ70mm

Φ45mm

果蔬架 F&V Stands

果蔬架 F&V Stands

- 可在货架里创建有特色的商品展示区，用来提供额外的优惠或者独特的分类；
- 提供清晰的产品分类；
- 坚固耐用的塑料。

- Create distinctive section in multi-deck showcase to call out premium or unique assortments;
- Can be used as a stock limiter as well;
- Offer clear product segmentation;
- Durable plastics for robust handling.



- 充分利用分层概念展示来最大限度地利用空间；
- 方便组装，和所有品牌的展示柜都能完美组合；
- 支架盒上的凹槽用来插入隔层，通常由3mm/5mm的亚克力制成。

Riser Box

- Acts as riser to create tiered display to maximize use of space;
- It is easy to install and works well with showcases of all brands;
- Groove on holder box are to accommodate optional sectional dividers usually made of 3mm/5mm Acrylic.

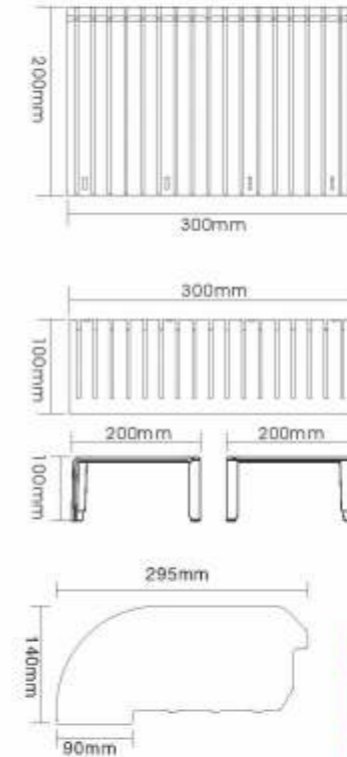
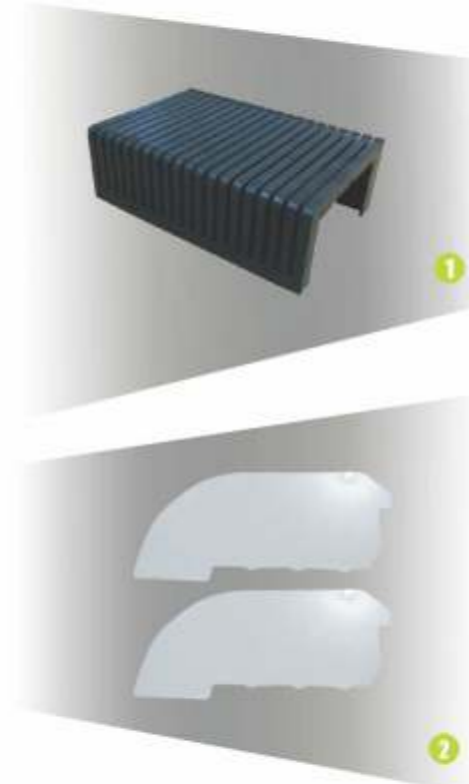

型号 (Item No.)	可拼装插槽式 (Divider Insert)	颜色 (Color)	材质 (Material)
1 FLD-Y7A	展示箱 (Holder Box)	黑色 (Black)	ABS
2 FLD-Y7B	隔断板 (Extendable Divider)	透明 (Transparent)	亚克力/PS (Acryli / PS)

陈列展示道具  
Display Props

陈列展示道具  
Display Props



多功能展示台 Multi-function display stand



可加



型号 (Item No.): FLD-Y8

尺寸 (Size): 308x180mm  
颜色 (Color): 透明色 (Transparent)  
材质 (Material): PET

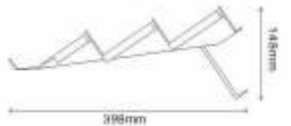
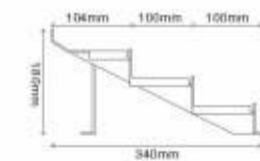
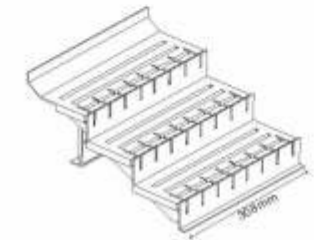

Usage one

Usage two

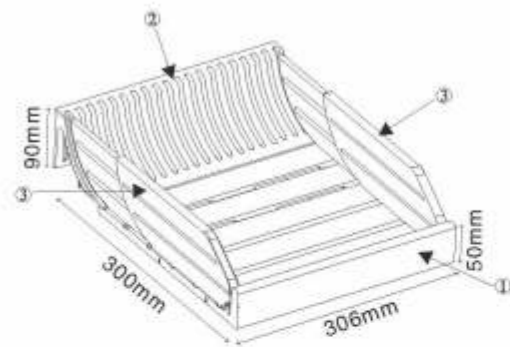

型号 (Item No.): FLD-Y6

尺寸 (Size): 306x300mm  
颜色 (Color): 木纹色、黑色 (Brown, Black)  
材质 (Material): ABS

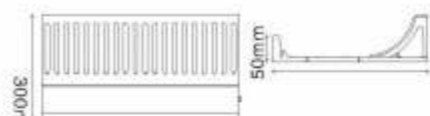
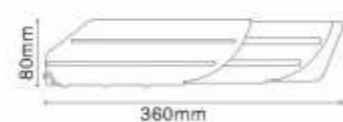
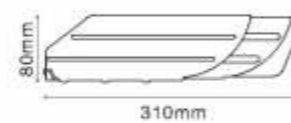

Standard Colours for Frames

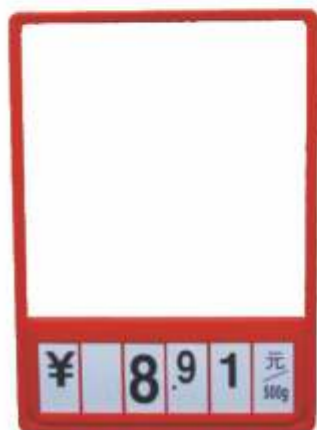

型号(Item No.): FLD-HA3  
框尺寸(Frame Size): 420x297mm  
数字片单片尺寸(Figure Size): 40x88mm



型号(Item No.): FLD-HA4  
框尺寸(Frame Size): 297x210mm  
数字片单片尺寸(Figure Size): 40x88mm



型号(Item No.): FLD-HA5  
框尺寸(Frame Size): 210x148mm  
数字片单片尺寸(Figure Size): 27x57mm

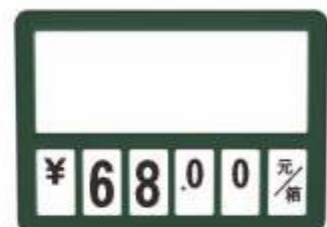

型号(Item No.): FLD-H10  
A4:297x210mm  
整体注塑(Whole Injection)

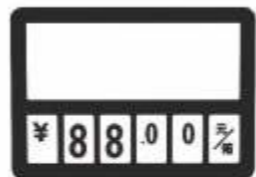

型号(Item No.): FLD-H9  
A5:210x148mm  
整体注塑(Whole Injection)



型号(Item No.): FLD-H21  
价格牌宽(Width): 225mm  
价格牌高(Height): 300mm  
数字片材质(Figure Material): 纸覆膜印刷数字  
(Paper coated digital printing)



型号(Item No.): FLD-H22  
价格牌宽(Width): 450mm  
价格牌高(Height): 300mm  
数字片材质(Figure Material): 纸覆膜印刷数字  
(Paper coated digital printing)

价格盒子 Price Cassettes



型号 (Item No.): FLD-H18  
框尺寸(Frame Size): 120x80mm



型号 (Item No.): FLD-H28  
框尺寸(Frame Size): 123x85mm  
数字片尺寸(Single Figure Size): 20x45mm



型号 (Item No.): FLD-H33  
框尺寸(Frame Size): 90x65mm  
数字片尺寸(Single Figure Size): 12x28mm



型号 (Item No.): FLD-H58  
框尺寸(Frame Size): 78x60mm  
数字片尺寸(Single Figure Size): 11x20mm



数字条示意图 Diagram of Numbers

每串数字均有0-9折叠数字片组成，用于变化价格来适应不同产品的需求。数字片的内容和颜色可定制。

Each backlet consists of 0-9 folded digital piece, which are used to transform numbers to meet the needs of different products. The content and color of digital can be customized.



1	2	1	2	1	2	元	元
3	4	3	4	3	4	分	分
5	6	5	6	5	6	角	角
7	8	7	8	7	8	元	元
9	¥	9	0	9	0	元	元
1	234	5	6	7			

价格盒子配件 不同的配件搭配,可展现不一样的效果。

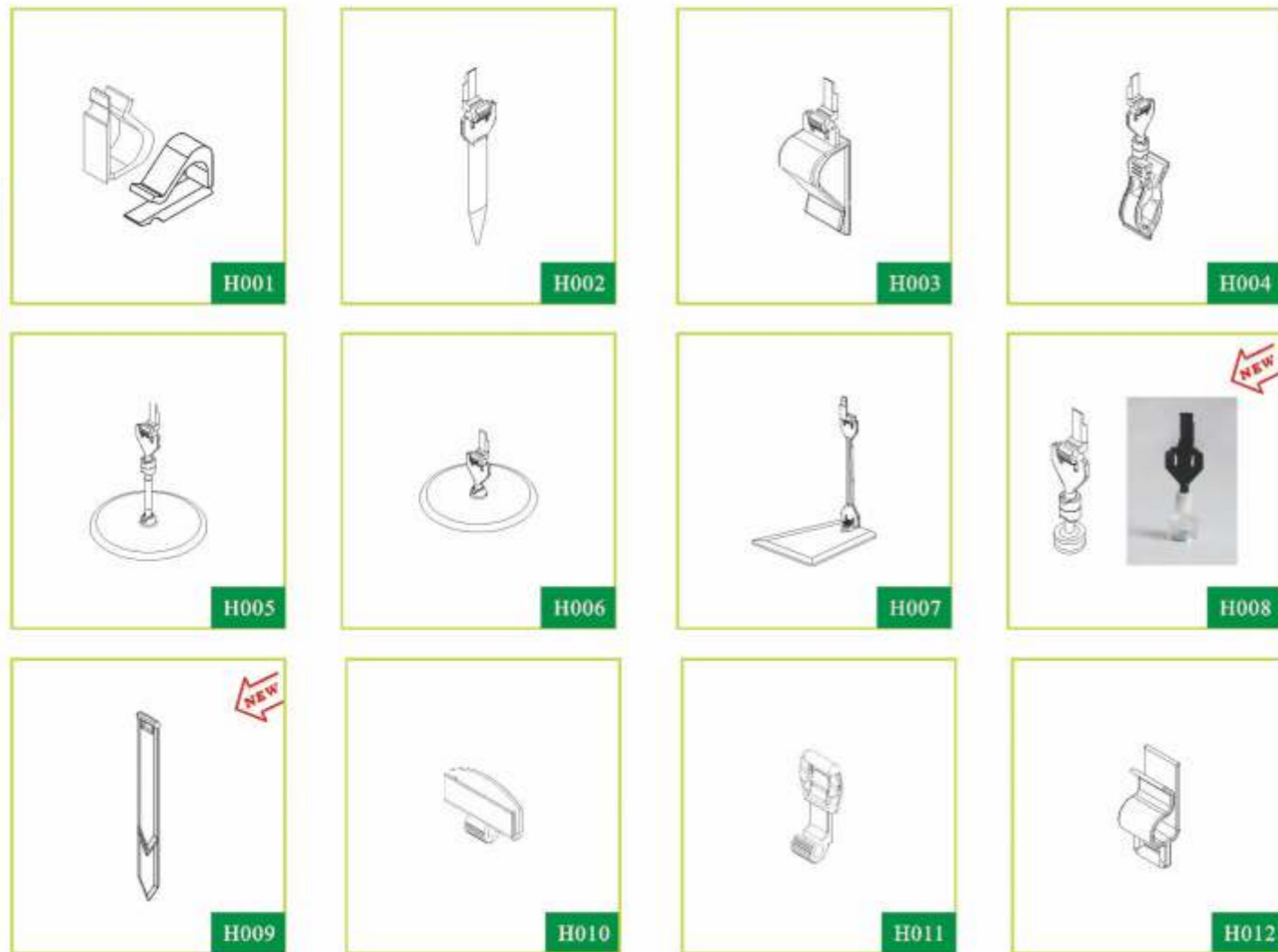

**!** 常规适用于H020、H021配件使用;  
也可适用于H002-H008 配件使用。  
General suitable for use with( H020、 H021) accessories;  
Also suitable for use with(H002-H008 )accessories.

型号(Item No.): FLD-H34

框尺寸 (Frame Size)	PVC尺寸 (PVC Size)
A6:152×110mm	A6:148×105mm
A7:110×82mm	A7:105×74mm
A8:80×57mm	A8:74×52mm

A7透明框 A7 Transparent Frame

**!** 常规适用于H022配件使用;  
也可适用于H20、H21、H001-H008 配件使用。  
General suitable for use with( H022) accessories;  
Also suitable for use with(H20、H21、H001-H008 )accessories.

型号(Item No.): FLD-H37

透明框尺寸(Frame Size) : 110x79mm  
可适用纸(Insert Size) : 105x74mm  
框材质(Material) : PC

框配件 不同的配件搭配,可展现不一样的效果。



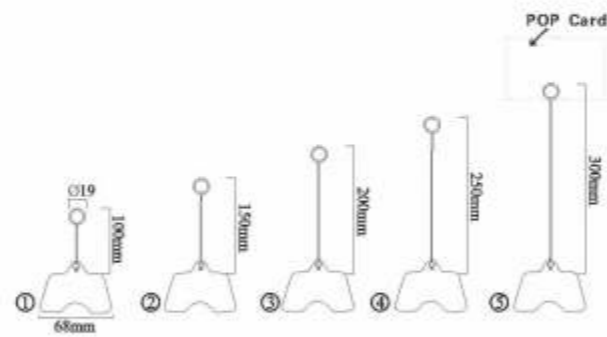

型号(Item No.): FLD-H41

高度 (Height)	底座尺寸 (Base Size)	表面处理 (Surface finished)	卡纸厚度 (POP thickness)
① 100mm	80x68mm	不锈钢 (Stainless steel) 喷塑 (黑色) Powder Coated (Black)	0.3-1mm
② 150mm			
③ 200mm			
④ 250mm			
⑤ 300mm			

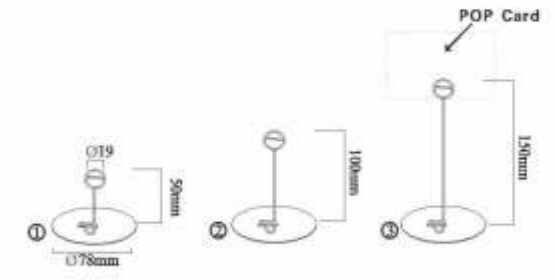

型号(Item No.): FLD-H45

高度 (Height)	底座尺寸 (Base Size)	表面处理 (Surface finished)	卡纸厚度 (POP thickness)
① 50mm	∅78mm	喷塑 (黑色) Powder Coated (Black)	0.3-1mm
② 100mm			
③ 150mm			

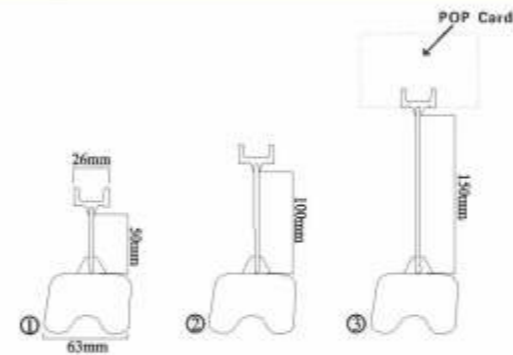

型号(Item No.): FLD-H42

高度 (Height)	底座尺寸 (Base Size)	表面处理 (Surface finished)	卡纸厚度 (POP thickness)
① 50mm	63x75mm	不锈钢 Stainless steel	0.3-1mm
② 100mm			
③ 150mm			

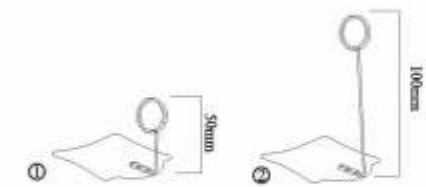

型号(Item No.): FLD-H46

高度 (Height)	底座尺寸 (Base Size)	表面处理 (Surface finished)	卡纸厚度 (POP thickness)
① 50mm	55x65mm	不锈钢 Stainless steel	0.3-1mm
② 100mm			



型号(Item No.): FLD-H43

高度 (Height)	底座尺寸 (Base Size)	表面处理 (Surface finished)	卡纸厚度 (POP thickness)
100mm	80x68mm	不锈钢 Stainless steel	0.3-1mm

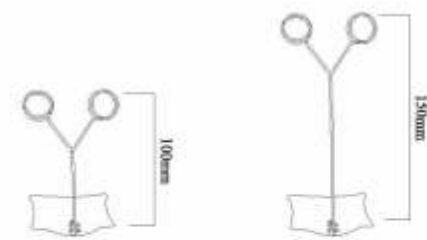

型号(Item No.): FLD-H47

高度 (Height)	底座尺寸 (Base Size)	表面处理 (Surface finished)	卡纸厚度 (POP thickness)
① 100mm	55x65mm	不锈钢 Stainless steel	0.3-1mm
② 150mm			

木箱 Wooden Box



型号 (Item No.): FLD-Q9

材质 (Material): 实木/多层板 (Solid/Multilayer Board)  
 尺寸 (Size): 450x300x300mm  
 600x450x200mm  
 450x300x200mm  
 颜色可定制 (Color can be customized)

土豆架 Potato Wagon



型号 (Item No.): FLD-Q10

型号 (Item No.)	产品名称 (Commodity)	尺寸 (Size)
①	FLD-Q10A 木箱 (Wooden Box)	720x545x12mm
②	FLD-Q10B 侧板 (Side Bottom Panel)	935x600x880mm
③	FLD-Q10C 金属支架 (Metal Body)	565x690x880mm
④	FLD-Q10D 前挡板 (Front Stopper Guard)	570x110mm

Produce Basket Series

Contact us for sizes customisation

所有的产品都是使用环保PP塑料, 纯手工制作, 做工精细, 编织得均匀而又牢固; 无毒无味, 可以在100摄氏度的水温下进行洗涤, 不会因为潮湿的天气而导致变质变霉, 解决了植物藤、竹子和木材上的缺点, 本产品不但环保而且美观, 总有一个款式适合你。

Overall use of environmental protection PP plastic, pure handmade, editing work fine, woven evenly and firmly; non-toxic tasteless, under 100 degrees heat, into hot water to wash, wash water, not due to wet weather metamorphism mildewy, put an end to the plant rattan, bamboo and wood, the disadvantages. This product is environmental Protection and beautiful, there are always a variety of styles for you.

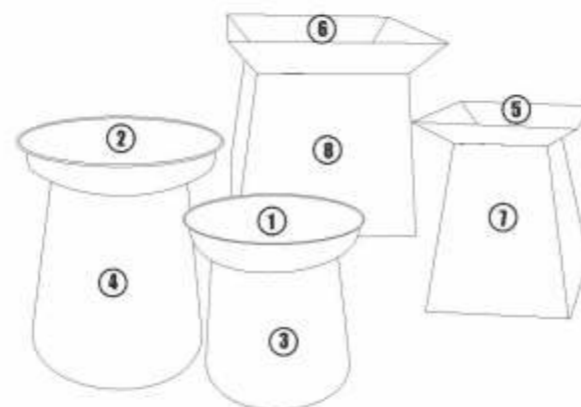

Round Plastic Base of Dark Brown



型号 (Item No.)	高度 (Height)	直径 (Diameter)	
①	FLD-Q11A	150mm	445mm
②	FLD-Q11B	195mm	590mm



型号 (Item No.)	高度 (Height)	直径 (Diameter)	
③	FLD-Q12A	500mm	280mm
④	FLD-Q12B	500mm	430mm

Square Plastic Base of Dark Brown



型号 (Item No.)	高度 (Height)	宽度 (Width)	
⑤	FLD-Q15A	150mm	440mm
⑥	FLD-Q15B	175mm	590mm

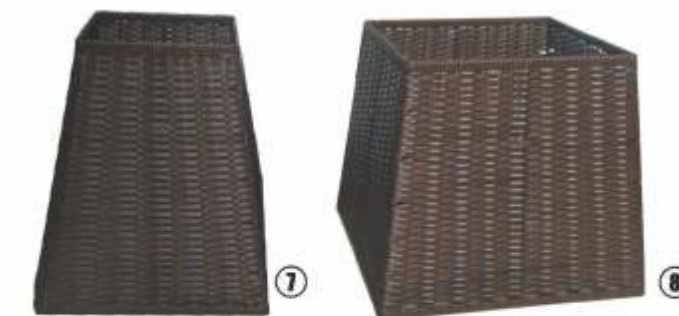

型号 (Item No.)	高度 (Height)	宽度 (Width)	
⑦	FLD-Q16A	500mm	280mm
⑧	FLD-Q16B	500mm	450mm

编织篮 Plastic Wicker Basket

木箱 Wooden Box



Produce Basket Series

Contact us for sizes customization

购物篮 • Supermarket Basket



尺寸(Size) : 400x300x100mm  
450x300x100mm  
颜色(Color) : 黄柳色(Yellow willow)  
黑棕色(Black Brown)



FLD-Q1052

购物篮 • Supermarket Basket



尺寸(Size) : 600x450x100mm  
颜色(Color) : 黄柳色(Yellow willow)  
黑棕色(Black Brown)

FLD-Q5008

圆形面包篮 • Round bread basket



尺寸(Size) : D400x100mm  
颜色(Color) : 米色(Beige)

FLD-Q1040

仿藤托盘 • Imitation rattan tray



尺寸(Size) : D270x45mm  
D310x50mm  
颜色(Color) : 米色(Beige)  
咖啡(Coffee)

FLD-Q1027B

碗式仿藤篮 • Bowl type imitation rattan basket



尺寸(Size) : D350x150mm  
颜色(Color) : 米色(Beige)

FLD-Q1003F

购物篮 • Supermarket Basket



尺寸(Size) : D400x100mm  
颜色(Color) : 黑棕色(Black Brown)

FLD-Q5040

椭圆形仿藤面包篮  
Oval imitation rattan bread basket



尺寸(Size) : 380x270x90mm  
颜色(Color) : 米色(Beige)

FLD-Q1020

购物篮 • Supermarket Basket



尺寸(Size) : 400x300x65mm  
颜色(Color) : 米色(Beige)  
咖啡(Coffee)

FLD-Q1021

竹制面包篮 • Bamboo bread basket



尺寸(Size) : 450x300x20mm  
颜色(Color) : 米色(Beige)

FLD-Q003

竹制面包篮 • Bamboo bread basket



尺寸(Size) : 300x300x20mm  
颜色(Color) : 米色(Beige)

FLD-Q004

仿藤垫 • Imitation rattan mat



尺寸(Size) : 400x300mm  
颜色(Color) : 咖啡(Coffee)

FLD-Q1004

购物篮 • Supermarket Basket



尺寸(Size) : 400x300x40mm  
颜色(Color) : 米色(Beige)  
咖啡(Coffee)

FLD-Q1021B

购物篮 • Supermarket Basket



尺寸(Size) : 450x340x70mm  
颜色(Color) : 米色(Beige)  
咖啡(Coffee)

FLD-Q1024

购物篮 • Supermarket Basket



尺寸(Size) : 450x340x40mm  
颜色(Color) : 米色(Beige)  
咖啡(Coffee)

FLD-Q1024B

仿藤垫 • Imitation rattan mat



尺寸(Size) : 600x400mm  
颜色(Color) : 咖啡(Coffee)

FLD-Q1006

仿藤毛巾篮 • Imitation rattan towel box



尺寸(Size) : 550x390x150mm  
颜色(Color) : 咖啡(Coffee)

FLD-Q1055

仿藤鞋篮 • Imitation rattan shoe basket



尺寸(Size) : D400x100mm  
颜色(Color) : 米色(Beige)

FLD-Q4046

编织篮  
Plastic Wicker Basket

编织篮  
Plastic Wicker Basket

嵌套产品箱 Nestable Produce Crate

嵌套式箱子方便使用者搬运、储存和运输。嵌套和堆叠功能在保证存储容量的同时，嵌套时能有效的减少高度的三分之一，从而节省存储和运输空间。

Our Nestable Produce Crates allow users an easy to handle,store and transportation option.Nestable & stackable functions have distinct double advantage of storing the full capacity while stacking and reducing the effective height to one third while nesting these crates,enabling the space saving on storage and transportation.



可叠加，节省空间  
Can be nested  
when empty to save space

型号(Item No.)	W	D	H	描述(Description)
FLD-HY002	400mm	300mm	120mm	嵌套的产品箱 Nestable Produce Crate 4030 H120
FLD-HY003	595mm	405mm	105mm	嵌套的产品箱 Nestable Produce Crate 4030 H105
FLD-HY004			165mm	嵌套的产品箱 Nestable Produce Crate 4030 H165
FLD-HY005			195mm	嵌套的产品箱 Nestable Produce Crate 4030 H195
FLD-HY006			245mm	嵌套的产品箱 Nestable Produce Crate 4030 H245

- 1、轻松安全嵌套。
- 2、快速冷却、温度控制和排水的通风设计。
- 3、嵌套的设计有助于在不使用的时候节省3/4的空间。
- 4、侧面可烫印，可印刷客户的信息和标志。
- 5、标签夹可附在篮子上。
- 6、材质PP，使用寿命长，特别适用于果蔬类商品。

- Easy and secure nesting.
- Ventilated designs for quick cooling,temperature control,and drainage.
- Nestable design helps to save 3/4 space when not in use,and for return journeys if used for transportation.
- The sides can be hot stamped and screen printed with customer's name and logo.
- Optional Label Holder can be attached onto baskets.
- Polypropylene,long service life ,especially suitable for Vegetable & Fruits storage.



购物篮 Shopping Basket

规格 / Size:L480xW320xH270mm



型号(Item No.): FLD-HY20

规格 / Size:L445xW285xH250mm



型号(Item No.): FLD-HY21

规格 / Size:L550xW330xH250mm



型号(Item No.): FLD-HY22

规格 / Size:L530xW380xH430mm



型号(Item No.): FLD-HY23

规格 / Size:L600xW345xH370mm



型号(Item No.): FLD-HY24

规格 / Size:L1025xW550xH1010mm



型号(Item No.): FLD-HY25

购物篮堆叠架 Shopping Basket Holder



型号(Item No.): FLD-HY3

尺寸(Size): 478x333mm  
表面处理(Surface Finished): 电镀(Plated Chrome)



型号(Item No.): FLD-HY4

尺寸(Size): 478x333mm  
表面处理(Surface Finished): 喷塑(Powder coated)  
颜色可定制(Color can be customized)

周转箱 Circulating Box

**颜色齐全:** 可定制各种颜色;  
**环保、节省空间:** 周转箱使用pp的材料, 不仅方便整理, 寿命还更长;  
**不易碎裂:** 适用于工厂物流中的运输、配送、存储、流通加工等环节。

A full range of color: Color can be customized;  
 Environmental-friendly and save space: The Circulating Box Using PP material, not only convenient to arrange, but also long life;  
 Not easy to be broken: It is suitable for transportation, Distribution, Storage, Circulation and processing in the factory logistics.



型号(Item No.): FLD-HY10

外尺寸(Outer Size): a600xb400xc220mm  
 内尺寸(Inner Size): a550xb360xc195mm



型号(Item No.): FLD-HY11

外尺寸(Outer Size): a400xb300xc280mm  
 内尺寸(Inner Size): a345xb250xc270mm



型号(Item No.): FLD-HY12

外尺寸(Outer Size): a400xb300xc148mm  
 内尺寸(Inner Size): a345xb250xc140mm



型号(Item No.): FLD-HY13

外尺寸(Outer Size): a400xb300xc220mm  
 内尺寸(Inner Size): a345xb250xc195mm



型号(Item No.): FLD-HY15

外尺寸(Outer Size): a300xb200xc148mm  
 内尺寸(Inner Size): a355xb150xc140mm



轻巧便捷

聚乙烯结构是一种经济的替代品。  
 耐用的注塑平台, 装有防滑橡胶垫, 防止滑动。  
 超平滑运行的非标脚轮可减少轧制, 增强流动性和操纵性。比起传统脚轮的负载移动, 能够减少所需工作量高达30%。  
 内置凹槽堆叠, 因而可达到最小化的占用空间。

SKATE BOARD

- Lightweight and portable.
- Polyethylene construction is an economical alternative. Durable injection moulded platform fitted with anti-slip rubber pads to prevent load from slipping.
- Super smooth running non-marking castors reduce rolling resistance and provide enhanced mobility and manoeuvrability.
- Reduces the amount of effort required to move load by up to 30% against conventional castors.
- Built in grooves for stacking, hence takes up minimal space.

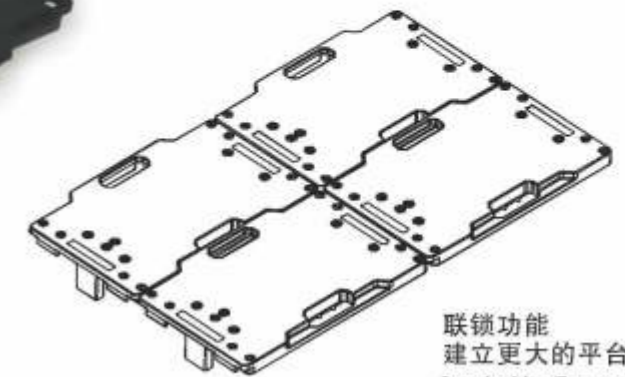

联锁功能  
 建立更大的平台  
 Interlocking Features  
 to build larger platforms



运行平稳的脚轮  
 Run a stationary easter

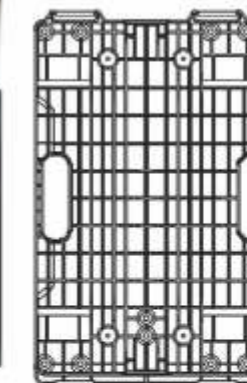

型号(Item No.): FLD-HY30

负载能力(Load Capacity): 150kg  
 均匀分布(Evenly Distributed)  
 颜色(Colours): 黑色、红色(Black, Red)  
 尺寸(Size): W420xD400xH100mm  
 脚轮(Castors): Four  $\Phi$ 65mm Swivel Castors  
 没有锁 (without Lock)

超市试吃台  
Supermarket tasting table

采用新型铝杆，高度可定制；  
可以选配牙签支架和垃圾桶，方便卫生；  
可广泛用于超市、商场的水果区、面包区、熟食区等。  
A new type of Aluminum tube, height can be customized.  
Toothpick holders and trash cans can be matched, which is convenient for clean.  
It can be widely used in supermarket, shopping mall, Fruit areas, Bread areas and Cooked food areas.



型号 (Item No.): FLD-H60-1

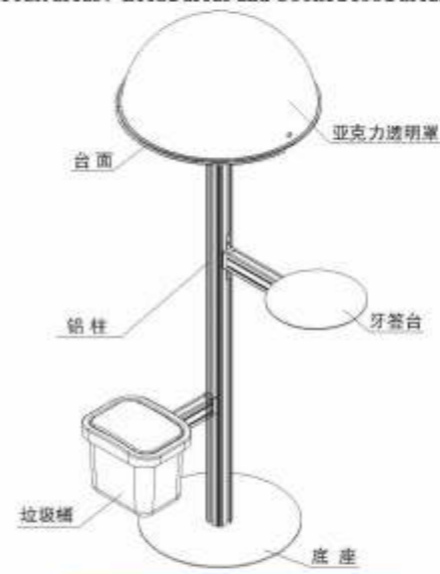

型号 (Item No.): FLD-H60-2



铝柱高 (Height) : 1000mm  
亚克力透明罩 (Acrylic Transparent Cover) :  
Φ400 x H182mm  
Φ360 x H172mm  
底座尺寸 (Base size): Φ320 x 3mm

型号 (Item No.): FLD-H38

型号 (Item No.): FLD-H39



摆放方式: 搭配挂件挂在铁柜双杆拉杆  
或者螺丝固定在木柜上。  
Display Mode: Collocation on pendant chording the rod  
or double shied screw in the wooden cabinet.

型号 (Item No.): FLD-H50a

规格 (Size) : 152x340x710mm  
容量 (Capacity) : 19L  
材质 (Material) : 食品级 PC (Food Grade PC)  
颜色 (Color) : 透明 (Clear)



型号 (Item No.): FLD-H50b

规格 (Size) : 152x330x570mm  
容量 (Capacity) : 13L  
材质 (Material) : 食品级 PC (Food Grade PC)  
颜色 (Color) : 透明 (Clear)



型号 (Item No.): FLD-H50c

规格 (Size) : 152x330x430mm  
容量 (Capacity) : 8L  
材质 (Material) : 食品级 PC (Food Grade PC)  
颜色 (Color) : 透明 (Clear)

摆放方式: 1. 搭配挂件挂在铁柜双杆拉杆  
或者螺丝固定在木柜上。  
2. 搭配底座摆放在货架层板上。

Display Mode: 1. Collocation on pendant chording the rod  
or double shied screw in the wooden cabinet.  
2. Can be placed on the board with the base.

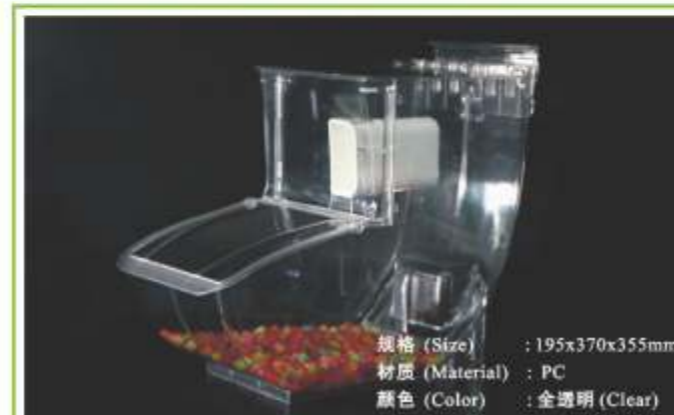

规格 (Size) : 195x370x355mm  
材质 (Material) : PC  
颜色 (Color) : 全透明 (Clear)

型号 (Item No.): FLD-H51



规格 (Size) : 295x385x345mm  
材质 (Material) : PC  
颜色 (Color) : 全透明 (Clear)

型号 (Item No.): FLD-H52

注塑糖果箱 Molding candy case



规格 (Size) : 295x295x260mm  
材质 (Material) : PC

型号 (Item No.): FLD-H36



# 价格牌系列

PRICE TICKET MERCHANDISING

本系列是一种新型价格标价的产品，有手拨旋转数字价格牌和翻页数字价格牌二个系列为主，配套广告板、封套使用，能有效提升卖场的购物氛围，改善卖场的环境。同时，可根据客户的要求，结合我们在标价促销方面的专业知识、完成与众不同的方案。

It is a new Price Signs. The Swivel-number and Flip Chart Price Tickets are suitable for the Poster Boards and POP Covers, the shopping atmosphere will be promoted effectively. Meanwhile, we can combine with professional knowledge to complete a special solution according to the customer requirements.



- 手拨旋转数字价格牌 Swivel Figure Price Tickets
- 翻页价格牌 Flip Charts
- 整体挤出价格牌 Whole Extrusion Price Boards
- 价格牌支架 Price Advertising Stands
- POP封套、保护膜 PVC Pockets, Protective Films



★ Digital Flip Numbering with Side Loading



型号 (Item No.): FLD-M1  
 尺寸 (Size): 580x380mm  
 规格 (Specifications): 4大2小 (The 4big 2 small)  
 数字颜色 (Digital color): 白底黑字 (White background with black text)

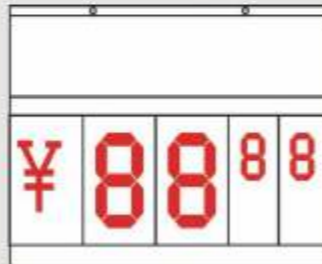

型号 (Item No.): FLD-M2  
 尺寸 (Size): 475x360mm  
 规格 (Specifications): 3大2小 (The 3big 2 small)  
 数字颜色 (Digital color): 白底黑字 (White background with red text)



型号 (Item No.): FLD-M3  
 尺寸 (Size): 410x310mm  
 规格 (Specifications): 4大2小 (The 4big 2 small)  
 数字颜色 (Digital color): 黄底红字 (Yellow background with red text)



型号 (Item No.): FLD-M4  
 尺寸 (Size): 340x300mm  
 规格 (Specifications): 3大2小 (The 3big 2 small)  
 数字颜色 (Digital color): 黄底红字 (Yellow background with red text)



型号 (Item No.): FLD-M6  
 广告板尺寸 (Advertising board Size): 580x300mm  
 标价板尺寸 (Sign price board Size): 580x480mm  
 规格 (Specifications): 4大2小 (The 4 big 2 small)  
 数字颜色 (Digital color): 黄底红字 (Yellow background with red text)



型号 (Item No.): FLD-M7  
 广告板尺寸 (Advertising board Size): 410x200mm  
 标价板尺寸 (Sign price board Size): 410x420mm  
 规格 (Specifications): 4大2小 (The 4 big 2 small)  
 数字颜色 (Digital color): 黄底红字 (Yellow background with red text)



型号 (Item No.): FLD-M8  
 广告板尺寸 (Advertising board Size): 475x480mm  
 标价板尺寸 (Sign price board Size): 475x250mm  
 规格 (Specifications): 3大2小 (The 3 big 2 small)  
 数字颜色 (Digital color): 黄底红字 (Yellow background with red text)



型号 (Item No.): FLD-M9  
 底板材质 (Material of the board): 1.2mmPVC  
 上部尺寸 (Upper size): 610 x 480mm  
 下部尺寸 (Bottom size): 610 x 115mm



型号 (Item No.): FLD-M17  
 尺寸 (Size): 335x420mm  
 规格 (Specifications): 3大2小 (The 3 big 2 small)  
 数字片颜色 (Digital color): 黄底红字 (Yellow background with red text)

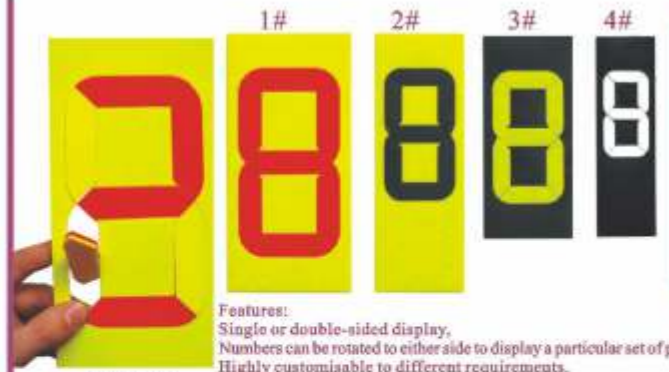

旋转数字 Swivel Number

Features:  
 Single or double-sided display.  
 Numbers can be rotated to either side to display a particular set of price.  
 Highly customisable to different requirements.

数字号 (Digital number)	尺寸 (Size)
1#	222 x 107mm
2#	222 x 77mm
3#	173 x 77mm
4#	173 x 32mm



手拨旋转数字价格牌 Swivel Figure Price Tickets

手拨旋转数字价格牌 Swivel Figure Price Tickets

注(Remark): 数字片从侧面插入  
Side Loading

常规翻页价格牌

Side-loading Flip Chart

单栏价格牌  
Single-side Flip chart



型号(Item No.): FLD-S1

尺寸(Size) : 420x275mm  
规格(Specifications) : 2大2小(The 2 Big 2 Small)  
数字片颜色(Digital Color) : 黄底红字  
(Yellow Background With Red Text)



型号(Item No.): FLD-S2

尺寸(Size) : 420x275mm 600x600mm  
规格(Specifications) : 2大2小(The 2 Big 2 Small)  
数字片颜色(Digital Color) : 黄底红字  
(Yellow Background With Red Text)



型号(Item No.): FLD-S3

尺寸(Size) : 420x450mm 600x600mm  
规格(Specifications) : 2大2小(The 2 Big 2 Small)  
数字片颜色(Digital Color) : 黄底红字  
(Yellow Background With Red Text)



型号(Item No.): FLD-S4

尺寸(Size) : 420x275mm 500x450mm 600x450mm  
规格(Specifications) : 3大2小(The 3 Big 2 Small)  
数字片颜色(Digital Color) : 黄底红字  
(Yellow Background With Red Text)



型号(Item No.): FLD-S5

尺寸(Size) : 600x450mm  
规格(Specifications) : 4大2小(The 4 Big 2 Small)  
数字片颜色(Digital Color) : 黄底红字  
(Yellow Background With Red Text)



双栏价格牌  
Double-Column Price Ticket



型号(Item No.): FLD-S6

尺寸(Size) : 300x300mm 420x420mm 450x450mm  
规格(Specifications) : 2大2小(The 2 Big 2 Small)  
数字片颜色(Digital Color) : 黄底红字  
(Yellow Background With Red Text)



型号(Item No.): FLD-S7

尺寸(Size) : 450x450mm 500x450mm 600x450mm 600x600mm  
规格(Specifications) : 3大2小(The 3 Big 2 Small)  
数字片颜色(Digital Color) : 黄底红字  
(Yellow Background With Red Text)



型号(Item No.): FLD-S8

广告板尺寸(Advertising Board Size) : 500x300mm  
价格牌尺寸(Sign Price Board Size) : 500x480mm  
规格(Specifications) : 3大2小(The 3 Big 2 Small)  
数字片颜色(Digital Color) : 黄底红字  
(Yellow Background With Red Text)



型号(Item No.): FLD-S9

广告板尺寸(Advertising Board Size) : 500x300mm  
价格牌尺寸(Sign Price Board Size) : 500x480mm  
规格(Specifications) : 3大2小(The 3 Big 2 Small)  
数字片颜色(Digital Color) : 黄底红字  
(Yellow Background With Red Text)



型号(Item No.): FLD-S40

尺寸(Size) : 350x250mm 500x400mm  
规格(Specifications) : 3大2小(The 3 Big 2 Small)  
数字片颜色(Digital Color) : 米黄底红字  
(Off-Yellow Background With Red Text)



挤出条 Extrusion Strips



型号(Item No.): FLD-JC01  
高度(Height) :16mm



型号(Item No.): FLD-JC02  
高度(Height) :29mm



型号(Item No.): FLD-JC03  
高度(Height) :36mm



型号(Item No.): FLD-JC04  
高度(Height) :22mm



型号(Item No.): FLD-JC05  
高度(Height) :26mm



型号(Item No.): FLD-JC06  
高度(Height) :16mm



型号(Item No.): FLD-JC07  
高度(Height) :22mm



型号(Item No.): FLD-JC08  
高度(Height) :36mm

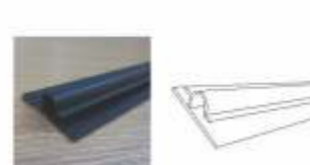

型号(Item No.): FLD-JC09  
高度(Height) :16mm



型号(Item No.): FLD-JC10  
高度(Height) :18mm



型号(Item No.): FLD-JC11  
高度(Height) :21mm



型号(Item No.): FLD-JC12  
高度(Height) :14mm

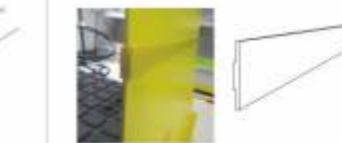

型号(Item No.): FLD-JC13  
高度(Height) :14mm



型号(Item No.): FLD-JC14  
高度(Height) :38mm

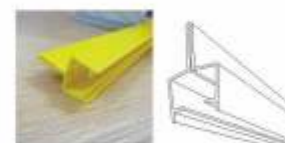

型号(Item No.): FLD-JC15  
高度(Height) :14mm

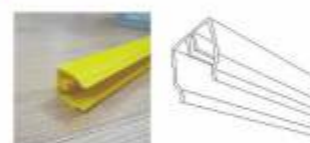

型号(Item No.): FLD-JC16  
高度(Height) :22mm



型号(Item No.): FLD-JC17  
高度(Height) :16mm



麦德龙式价格牌  
Top-loading Flip Chart

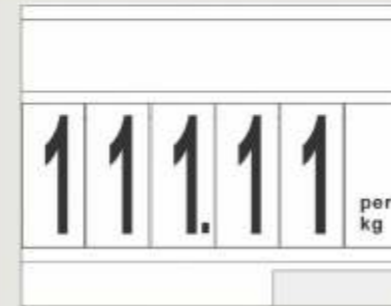

●Double-Column Price Ticket

型号(Item No.): FLD-S10  
尺寸(Size):430×335mm  
底板(Board):1.8mm厚度白色的PVC(1.8mm white PVC)  
数字片(Numerals):0.3mm厚度的白色PVC(0.3mm white PVC)



●Double-Column Price Ticket

品名栏配A4纸张  
Suit for A4 size advertising board

型号(Item No.): FLD-S18  
尺寸(Size) :440×330mm  
规格(Specifications) :3大2小(The 3 big 2 small)  
数字片颜色(Digital color) :黑底白字  
(Black background with white text)

●Double-Column Price Ticket



型号(Item No.): FLD-S15

尺寸 (Size)	规格 (Specifications)	数字片颜色 (Digital Color)
S15:420×350mm	3大2小	黄底红字 Yellow background with red text
S16:420×580mm	The 3 big 2 small	白底黑字 White background with black text



型号 (Item No.): FLD-S16

●Double-Column Price Ticket



型号 (Item No.): FLD-S19



型号 (Item No.): FLD-S20



尺寸 (Size)	规格 (Specifications)	数字片颜色 (Digital Color)
S19:600×500mm	8大 8 big numbers	黄底黑字 Yellow Background With Black Text
S20:800×710mm	6大 6 big numbers	黄底黑字 Yellow Background With Black Text



国外部分价格牌展示 Customized Price Flip Chart ▶▶▶▶▶▶▶▶



型号 (Item No.): FLD-S27  
 尺寸 (Size): 610x305mm  
 规格 (Specifications): 5大 (5 big numbers)  
 数字片颜色 (Digital color): 黄底黑字  
 (Yellow Background With Black Text)



型号 (Item No.): FLD-S28  
 尺寸 (Size): 800x460mm  
 规格 (Specifications): 8大 (8 big numbers)  
 数字片颜色 (Digital color): 黑底白字  
 (Black Background With White Text)



型号 (Item No.): FLD-S29  
 尺寸 (Size): 280x305mm  
 规格 (Specifications): 3大2小 (The 3 big 2 small)  
 数字片颜色 (Digital color): 黑底白字  
 (Black Background With White Text)



型号 (Item No.): FLD-S30  
 尺寸 (Size): 210x348mm  
 规格 (Specifications): 6大 (The 6 big)  
 数字片颜色 (Digital color): 黑底白字  
 (Black Background With White Text)



型号 (Item No.): FLD-S31  
 尺寸 (Size): 600x700mm  
 规格 (Specifications): 2大2小 (The 2 big 2 small)  
 数字片颜色 (Digital color): 黑底白字  
 (Black Background With White Text)



型号 (Item No.): FLD-S32  
 尺寸 (Size): 860x480mm  
 规格 (Specifications): 3大2小 (The 3 big 2 small)  
 数字片颜色 (Digital color): 黑底白字  
 (Black Background With White Text)

Advertising Board

画面内容和尺寸可随意定制  
 Printing content and size can be customized



说明:

只要往上推出数字片, 就能完成顶端的便签更换, 比传统的侧面移出方式更加便捷有效。

Instructions:

As long as the number of tablets to push up, it can be removed from the top of the note, in order to complete the change of figures, More convenient and efficient than the traditional form of taking out from the side.

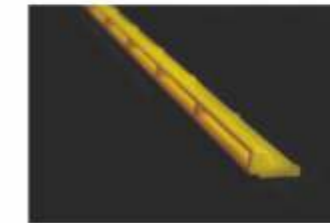
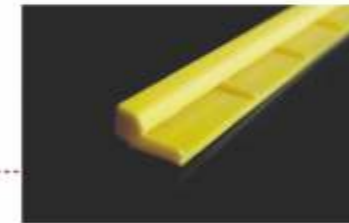

型号 Item No.	长度 Length	规格 Specifications	数字片适用宽度 Figure Width
FLD-MD01	900mm	6大 6 big numbers	146mm
FLD-MD02	800mm	6大 6 big numbers 8大 8 big numbers	129mm 96mm
FLD-MD03	600mm	6大 6 big numbers 8大 8 big numbers	96mm 71mm
FLD-MD04	500mm	3大2小 3 big 2 small numbers	3x108mm 2x77mm
FLD-MD05	430mm	6大 6 big numbers 8大 8 big numbers	68mm 50mm
FLD-MD06	420mm	6大 6 big numbers 3大2小 3 big 2 small numbers	66mm 3x88mm 2x68mm
FLD-MD07	400mm	2大2小 2 big 2 small numbers 4大 4 big numbers	2x130mm 2x61mm 95mm
FLD-MD08	297mm	6大 6 big numbers 8大 8 big numbers	45mm 33mm
FLD-MD09	210mm	6大 6 big numbers	31mm



型号(Item No.): FLD-S23



型号(Item No.): FLD-S26



型号(Item No.): FLD-S24



型号(Item No.): FLD-S25

型号 Item No.	宽 Width	高 Height	数字片颜色 Digital Color
FLD-S23	320mm	210mm	蓝底白字 Blue Background with white text
FLD-S26	435mm		
FLD-S24	430mm	360mm	
FLD-S25	760mm		

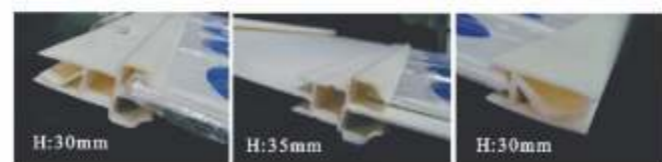

单栏 Single-Column

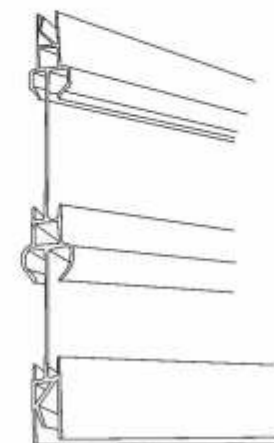

双栏 Double-Column



尺寸(Size): W700 x H510mm 型号(Item No.): FLD-S50

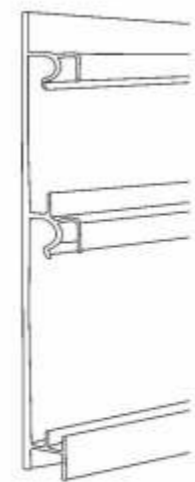

双栏 Double-Column



价格牌T型架 • T type price stand

型号(Item No.): FLD-P1  
 调节高度(Adjustable Height): 1000-1900mm  
 上方管(Upper Square Tube) : 15x15mm  
 下方管(Bottom Square Tube) : 20x20mm  
 底盘尺寸(Base Size) : 340x280x2mm  
 表面处理(Surface Finished) : 喷塑(Powder Coated)

价格牌方框架 • Square type price stand

型号(Item No.): FLD-P2-2  
 调节高度(Adjustable Height): 1000-1900mm  
 上方管(Upper Square Tube) : 12.7mm  
 下方管(Bottom Square Tube) : 16mm  
 底盘尺寸(Base Size) : 340x280x2mm  
 表面处理(Surface Finished) : 喷塑(Powder Coated)

货架价格牌T型架 • Shelf Price Board T type Holder

型号(Item No.): FLD-P5  
 尺寸 : 可定制  
 Size : Can Be Customized  
 表面处理 : 喷塑  
 Surface Finished : Powder Coated

货架价格牌T型架 • Shelf Price Board T type Holder

型号(Item No.): FLD-P6  
 调节高度(Adjustable Height): 400-750mm  
 上方管(Upper Square Tube) : 15x15mm  
 下方管(Bottom Square Tube) : 20x20mm  
 表面处理(Surface Finished) : 喷塑(Powder Coated)

价格牌支架 • Shelf Price Board

型号(Item No.): FLD-P7  
 总高度(Height): 1750mm  
 圆管直径(Tube Diameter) : 19mm  
 表面处理(Surface Finished) : 喷塑黑色(Powder Coated Black)  
 底盘尺寸(Base Size) : Φ350x3mm



价格牌支架是用来支撑价格牌的，我们可以根据使用领域为您定制特殊结构，使用简单，易于操作。

Price ticket stand used for supporting price ticket. We can according to the using areas customize the special structure for you. It is simple to use, easy to operate.

整体挤出价格牌  
Whole Extrusion Price Boards

价格牌支架  
Price Advertising Stands



型号(Item No.): FLD-B1  
外尺寸(Outer Size): W450xH500mm  
材质(Material): PVC  
厚度(Thickness): 0.28mm



型号(Item No.): FLD-B2  
外尺寸(Outer Size): W420xH580mm  
材质(Material): PVC  
厚度(Thickness): 0.28mm



型号(Item No.): FLD-B3  
外尺寸(Outer Size): W400xH450mm  
材质(Material): PVC  
厚度(Thickness): 0.28mm



型号(Item No.): FLD-B4  
外尺寸(Outer Size): W580xH420mm  
材质(Material): PVC  
厚度(Thickness): 0.28mm

三角牌搭配封套示意图  
Triangle card



Item No.: FLD-B5  
材质(Material): PVC  
厚度(Thickness): 0.28mm



Content and size of triangle board can be customized



型号(Item No.): FLD-B6  
尺寸(Size): 可定做 (Customized)  
颜色(Color): 透明、磨砂  
(Transparent or frosted)  
厚度(Thickness): 0.28mm



型号(Item No.): FLD-B7  
尺寸(Size): 可定做 (Customized)  
颜色(Color): 透明、磨砂  
(Transparent or frosted)  
厚度(Thickness): 0.28mm



型号(Item No.): FLD-B8/B9/B10  
尺寸(Size): 可定做 (Customized)  
颜色(Color): 透明、磨砂 (Transparent or frosted)  
材质(Material): PVC软胶套 (Soft PVC pocket)  
厚度(Thickness): 0.3mm

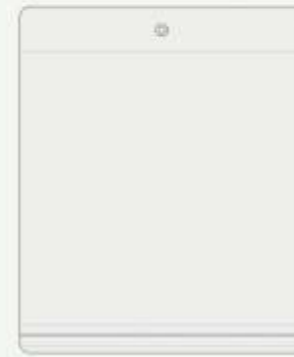

型号(Item No.): FLD-B11  
外尺寸(Outer Size): W190.5x H292mm  
内尺寸(Inner Size): W184xH254mm  
单层厚度(Thickness): 0.2mm  
颜色(Color): 透明、磨砂 (Transparent or frosted)



型号(Item No.): FLD-B13  
尺寸(Size): W420xH580mm  
材质(Material): PVC  
厚度(Thickness): 0.28mm

用法:  
把促销信息打印出来, 然后插入封套中  
易于更换, 方便使用

Usage:  
Printing the promotion information then insert to the  
poster pocket. It is easy to change and convenient to use.



PVC封套、保护膜  
PVC Pockets, Protective Films

PVC封套、保护膜  
PVC Pockets, Protective Films

# 货架陈列系列

ON-SHELF MERCHANDISING

本系列产品用于货架的分类与促销，色彩鲜艳，品种齐全；同时如果进行良好、巧妙的陈列展示，可吸引消费者目光，营造商品的卖点，提升销量。

It is used for the shelf classification and promotion,colorful and various.It will attract customers attention,create selling point and promote sales in the condition of cleverly display.

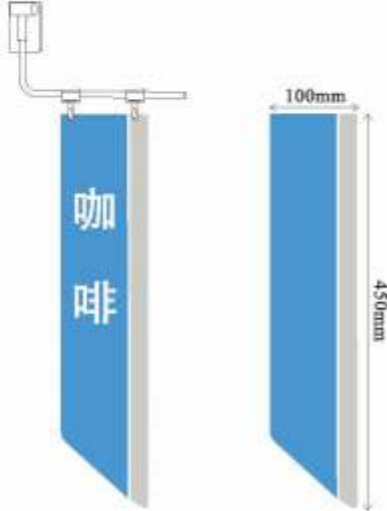

- 小分类、促销卡片及配件 Shelf Talkers
- 货架价签条 Data Strips
- 金属挂钩及配件 Metal Hooks
- 分隔板 Shelf Dividers
- 推进器 Shelf Product Pushers

颜色可定制  
文字即时贴粘贴  
Size and color can be customize used with sticky note.

型号 (Item No.): FLD-G1  
铝杆尺寸(Aluminum Pole Size): W200mm x H100mm  
分类牌尺寸(AD Board Size): W100mm x H450mm





FLD-G6A 立式弧形分类架  
Magnetic Display Stand

FLD-G6B 立式直杆分类架

高度(Height) : 500mm  
直径(Diameter) :  $\Phi$ 8mm  
表面处理(Surface finished) : 喷漆(Powder Coated)





颜色可定制  
文字即时贴粘贴

型号 (Item No.): FLD-G2  
铝杆尺寸(Aluminum Pole) : W180mm x H500mm  
分类牌尺寸(Ad Board Size) : W440mm x H220mm

型号 (Item No.): FLD-G3  
铝杆尺寸(Aluminum Pole) : W200mm x H100mm  
铝杆直径(Aluminum Pole Diameter) :  $\Phi$ 9mm



型号 (Item No.): FLD-G9  
直径(Diameter) : 105mm  
材质(Material) : UV印刷(UV printed)  
厚度(Thickness) : 0.4mm PVC





型号 (Item No.): FLD-G4

型号 (Item No.): FLD-G5

铝杆尺寸(Aluminum Pole Size) : W200mm x H100mm  
铝杆直径(Aluminum Pole Diameter) :  $\Phi$ 9mm



型号 (Item No.): FLD-G10  
尺寸(Size) : 120x120mm  
材质(Material) : UV印刷(UV printed)  
厚度(Thickness) : 0.4mm PVC

型号 (Item No.): FLD-G11  
直径(Diameter) : 105mm  
材质(Material) : UV印刷(UV printed)  
厚度(Thickness) : 0.4mm PVC





省  
Promotion



新  
Promotion



低  
Promotion



值  
Promotion

**型号 (Item No.): FLD-G12**

尺寸 (Size) : 255×105mm  
材质 (Material) : UV印刷 (UV printed)  
厚度 (Thickness) : 0.4mm PVC

★ 各种不同形状的促销卡片都可订制  
Various promotional cards with different shapes can be customized



Carrefour Products



جدید  
New



أقل الأسعار  
lowest Price



PRICES YOU CAN TRUST



WEEKLY CHECKED!



İNDİRİM



PROMOTION



A leading brand



FLD-G13A



FLD-G13B



FLD-G13C



FLD-G13D



FLD-G13E



FLD-G13F



FLD-G14



FLD-G17



FLD-G18



FLD-G19

尺寸和画面可订制  
Size and content can be customized

收銀條尺寸 (Size): W405xH40mm

促销挂条 • Clip strip



型号 (Item No.): FLD-G21

头上尺寸 (Header Size): W75xH35mm  
钩距 (Hook Spacing): 18mm  
长钩 (Length/Hooks): 650mm/12Hooks  
宽度 (Width): 29mm  
材质 (Material): PVC



型号 (Item No.): FLD-G21-1

头上尺寸 (Header Size): W60xH37mm  
钩距 (Hook Spacing): 20mm  
长钩 (Length/Hooks): 680/12Hooks  
宽度 (Width): 18mm  
材质 (Material): PP



型号 (Item No.): FLD-G22

封套净尺寸 (PVC Cover Size): 175×125mm  
材质 (Material): PVC



型号 (Item No.): FLD-G26

封套净尺寸 (PVC Cover Size): 可定制 (Can be customized)  
材质 (Material): PVC



FLD-G22A



FLD-G22B



FLD-G26A



型号 (Item No.): FLD-G24

封套净尺寸 (PVC Cover Size): 28x30mm  
材质 (Material): PVC



型号 (Item No.): FLD-G25

塑料条尺寸: 长度可定制  
(PVC Strip Size): Length Can Be Customized  
底座 (Base): 磁性 (Magnet)



卡纸高度(Label height):39mm  
FLD-W1



卡纸高度(Label height):39mm  
FLD-W2

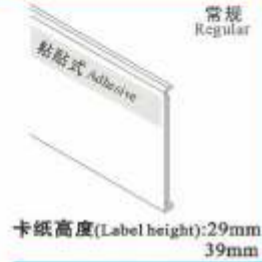

卡纸高度(Label height):29mm  
39mm  
FLD-W3



卡纸高度(Label height):39mm  
FLD-W4

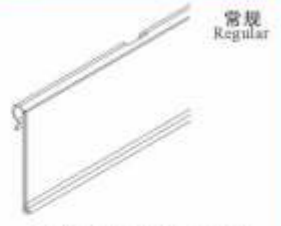

卡纸高度(Label height):39mm  
FLD-W5



卡纸高度(Label height):75mm  
FLD-W6



卡纸高度(Label height):105mm  
FLD-W7



卡纸高度(Label height):39mm  
FLD-W8



卡纸高度(Label height):64mm  
FLD-W9



卡纸高度(Label height):39mm  
FLD-W10



卡纸高度(Label height):29mm  
FLD-W11



卡纸高度(Label height):29mm  
FLD-W12



卡纸高度(Label height):39mm  
FLD-W13



卡纸高度(Label height):40mm  
FLD-W14

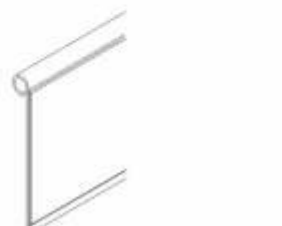

卡纸高度(Label height):60mm  
FLD-W15



卡纸高度(Label height):39mm  
FLD-W16



卡纸高度(Label height):39mm  
FLD-W17



卡纸高度(Label height):108mm  
FLD-W18

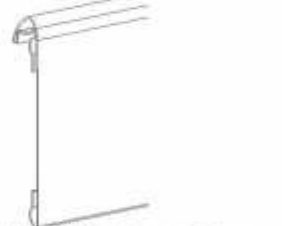

卡纸高度(Label height):78mm  
FLD-W19

货架价签条  
Data Strips

货架价签条  
Data Strips



卡纸高度(Label height):84mm

FLD-W20



卡纸高度(Label height):29mm

FLD-W21



卡纸高度(Label height):78mm

FLD-W22



卡纸高度(Label height):39mm

FLD-W23



卡纸高度(Label height):39mm

FLD-W24



卡纸高度(Label height):29mm

FLD-W25



卡纸高度(Label height):30mm

FLD-W26



卡纸高度(Label height):69mm

FLD-W27



卡纸高度(Label height):33mm

FLD-W28



卡纸高度(Label height):34mm

FLD-W29



卡纸高度(Label height):29mm

FLD-W30



卡纸高度(Label height):39mm

FLD-W31

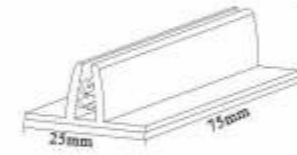

FLD-W32

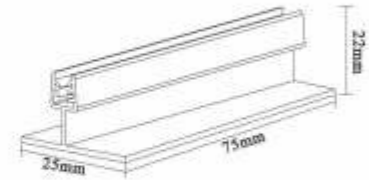

FLD-W33

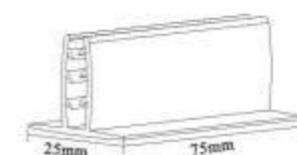

FLD-W34

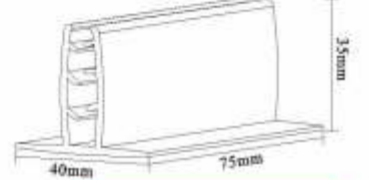
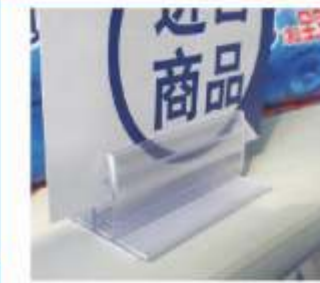

FLD-W35

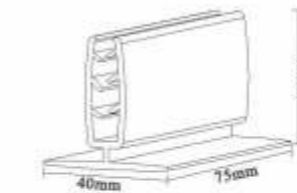
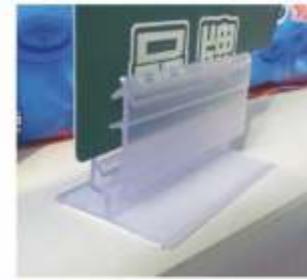

FLD-W36

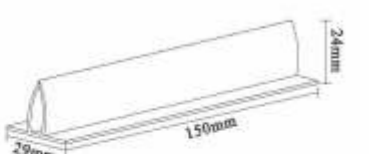

FLD-W37

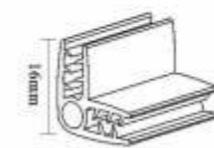

FLD-W39

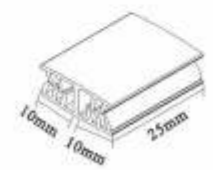



FLD-W40



货架价签条  
Data Strips

货架价签条  
Data Strips



 <p><b>型号 (Item No.): FLD-HJ01</b> 长度 (Length) : 75mm 150mm 230mm 铁线直径 (Wire Diameter) : 5mm</p>	 <p><b>型号 (Item No.): FLD-HJ02</b> 长度 (Length) : 280mm 铁线直径 (Wire Diameter) : 5mm</p>	 <p><b>型号 (Item No.): FLD-HJ03</b> 长度 (Length) : 220mm 铁线直径 (Wire Diameter) : 5mm</p>
 <p><b>型号 (Item No.): FLD-HJ04</b> 长度 (Length) : 230mm 铁线直径 (Wire Diameter) : 5mm</p>		
 <p><b>型号 (Item No.): FLD-HJ05</b> 长度 (Length) : 75mm 150mm 230mm 铁线直径 (Wire Diameter) : 5mm</p>	 <p><b>型号 (Item No.): FLD-HJ06</b> 长度 (Length) : 210mm 300mm 铁线直径 (Wire Diameter) : 4mm</p>	 <p><b>型号 (Item No.): FLD-HJ07</b> 长度 (Length) : 150mm 230mm 铁线直径 (Wire Diameter) : 4mm</p>
 <p><b>型号 (Item No.): FLD-HJ08</b> 长度 (Length) : 75mm 150mm 230mm 铁线直径 (Wire Diameter) : 5mm</p>	 <p><b>型号 (Item No.): FLD-HJ09</b> 长度 (Length) : 220mm 铁线直径 (Wire Diameter) : 5mm</p>	<p>方管挂钩</p>  <p><b>型号 (Item No.): FLD-HJ10</b> 长度 (Length) : 150mm 200mm 铁线直径 (Wire Diameter) : 6mm</p>
<p>锌双挂钩 Zinc Double Hook</p>  <p><b>型号 (Item No.): FLD-HJ11</b> 长度 (Length) : 150mm 500mm 1000mm 可定制 (Can Be Customized) 铁线直径 (Wire Diameter) : 2mm</p>	<p>弹簧钩 Spring Hook</p>  <p><b>型号 (Item No.): FLD-HJ12</b> 长度 (Length) : 270mm 可定制 (Can Be Customized) 最大可承受重量 (Maximum Load) : 2Kg</p>	

金属挂钩及配件  
Metal Peg Hooks

金属挂钩及配件  
Metal Peg Hooks



规格多样、安装方便、节省空间、实用性强。  
Advantages: Various specification, Convenient installation, Save space, Strong practicability.  
Applications: Used in Supermarket counters, Clothing shop, Mobile phone store etc.



塑料PET材料的优点:

- 1.有良好的力学性能,冲击强度比其他材料高3-5倍,良好的折叠性能。
- 2.耐油性,耐酸碱,耐碱性,耐大多数的溶剂。
- 3.卓越的耐高温和耐低温,长期可在120°C的高温下使用,短期可在150°C的高温下使用,可耐零下70°C的低温。在高温和低温下,对机械性能影响不大。
- 4.气体和水蒸气透过率低,这表明能够良好的阻挡空气,水,油和异味。
- 5.透明度高,可阻挡紫外线,光泽度好。
- 6.无毒无味,健康安全,可以直接用做食品的包装。
- 7.性价比高。

The advantages of Plastic PET material:

- 1) Well-mechanical property, The impact strength is 3-5 times more than other material, Good folding.
- 2) Resistance to oil, fat, acid, Dilute alkali, Resistant most solvents.
- 3) Excellent resistance to high, and low temperature, Long-term use in the 120°C temperature range, Short-term use can resistance to high temperature 150°C, To -70°C low temperature resistance, and high and low temperature has little influence on the mechanical properties.
- 4) Gas and water vapor permeability is low, It means has good resistance of gas, water, oil and peculiar smell.
- 5) High transparency, Can block ultraviolet light, good gloss.
- 6) Non-toxic, Odorless, Well health security, Can be directly used in food packaging.
- 7) High Cost-Effective.

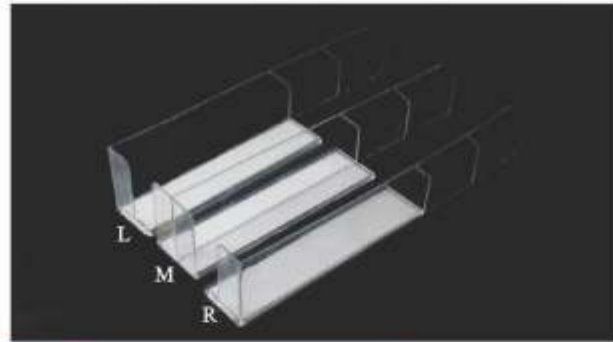

型号(Item No.): FLD-X1

尺寸(Size) : L250xH50xT1.5mm  
材质(Material) : PET  
配白色磁条(With white magnetic strip)

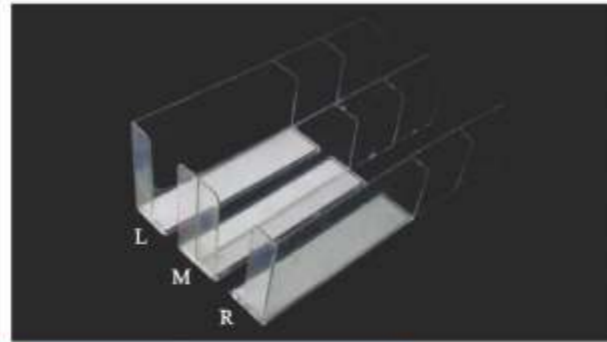

型号(Item No.): FLD-X2

尺寸(Size) : L250xH80xT1.5mm  
材质(Material) : PET  
配白色磁条(With white magnetic strip)

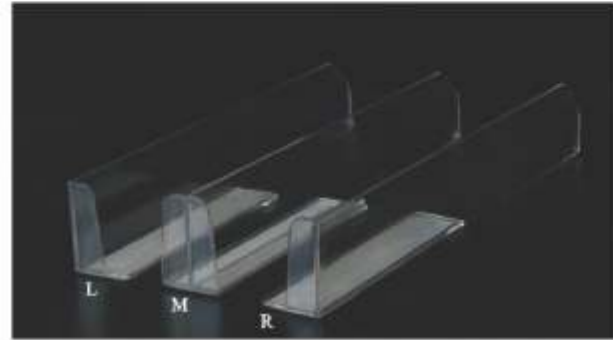

型号(Item No.): FLD-X7

尺寸(Size) : L250/200 x H50 x T1.5mm  
材质(Material) : PS  
配白色磁条(With white magnetic strip)

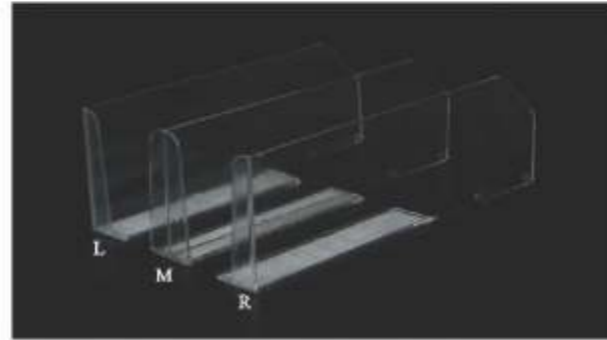

型号(Item No.): FLD-X8

尺寸(Size) : L300/250/200 x H80 x T1.5mm  
材质(Material) : PS  
配白色磁条(With white magnetic strip)

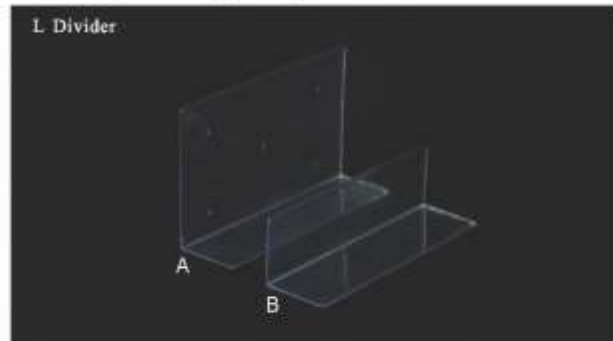

型号(Item No.): FLD-X3

尺寸(Size) : (A) L240xW70xH150mm  
(B) L240xW70xH70mm  
材质(Material) : PS

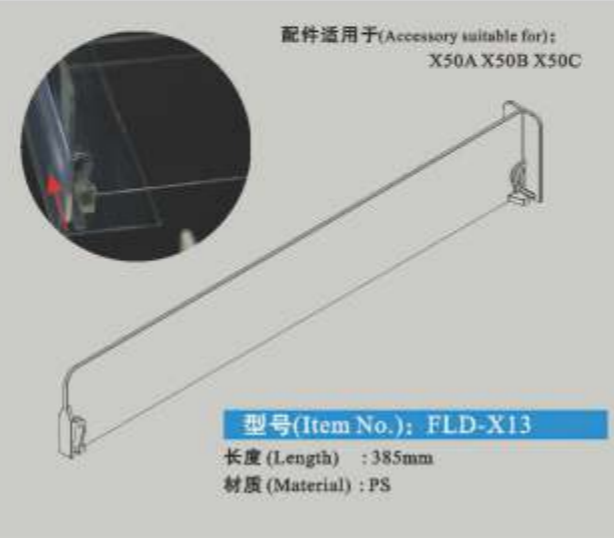

配件适用于(Accessory suitable for): X50A X50B X50C

型号(Item No.): FLD-X13

长度(Length) : 385mm  
材质(Material) : PS

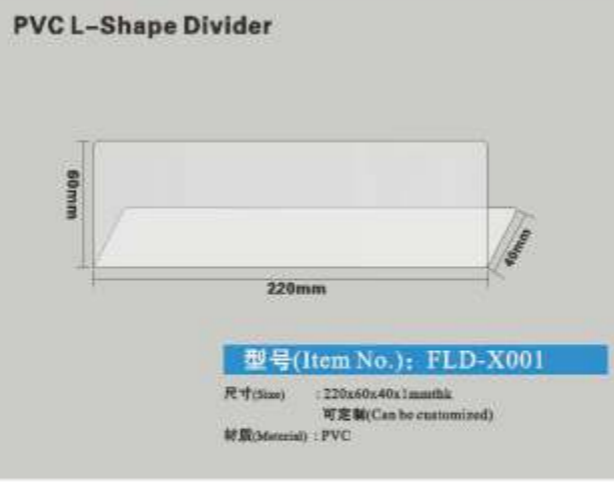

PVC L-Shape Divider

型号(Item No.): FLD-X001

尺寸(Size) : 220x60x40x1mmthk  
可定制(Can be customized)  
材质(Material) : PVC



55mmH PVC L-Shape Divider

型号(Item No.): FLD-X002

尺寸(Size) : H55x110mm/220mm/320mm x 1mmthk  
可定制(Can be customized)  
材质(Material) : PVC

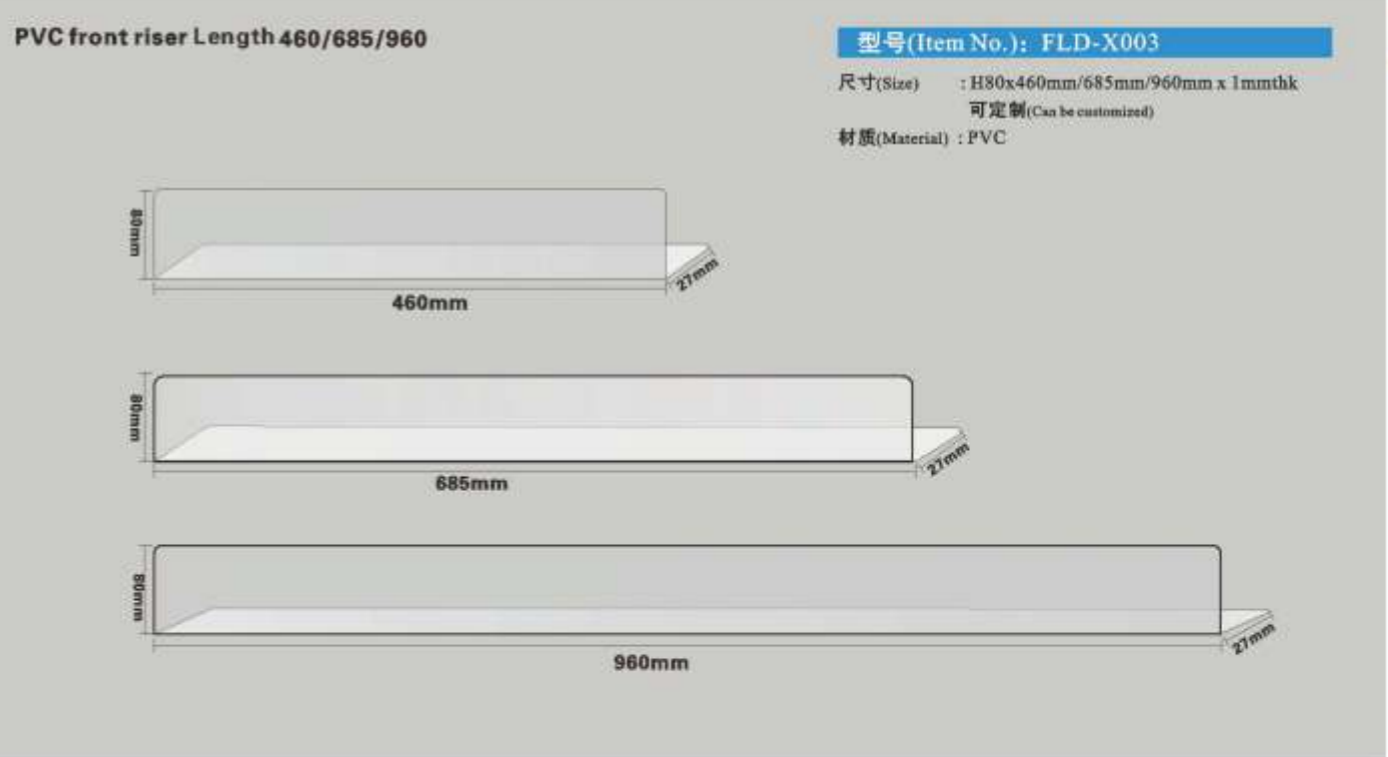

PVC front riser Length 460/685/960

型号(Item No.): FLD-X003

尺寸(Size) : H80x460mm/685mm/960mm x 1mmthk  
可定制(Can be customized)  
材质(Material) : PVC

分隔板  
Shelf Dividers

分隔板  
Shelf Dividers

Back Support Series



后支撑架 • Back Support



- 有助于整洁、推销您的商品;
- 磁条强度大, 可以稳固的放在货架上;
- 此产品适用于货架尾端摆放; 让物品能整齐地排列并防止堆放物品倾倒。

Our back supports are great merchandising aids used to face up flat packed products in your stores. With the support of magnetic strip's strength, they are the easy aid for re-merchandising and help to ensure tidier display for flat packed merchandise. Can be a stock limiter as well.



型号(Item No.): FLD-X5

尺寸(Size) : L45xW80xH100mm  
材质(Material) : PET  
配白色磁条(With white magnetic strip)

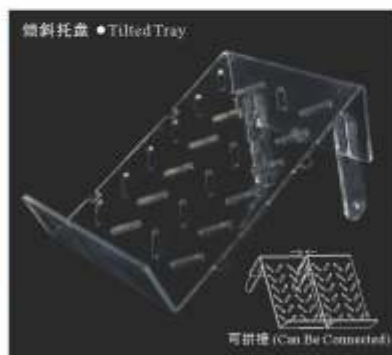

倾斜托盘 • Tilted Tray



可以在标准的直立货架上进行30°—45°的展示, 组装零件可以根据部分或是整个货架的宽度进行使用。

Can create 30° and 45° Degrees display on standard straight shelves. Modular parts that enable to work with segments or entire shelf width.

型号(Item No.): FLD-X6

尺寸(Size) : L145xW220xH70mm  
材质(Material) : PET



型号(Item No.): FLD-X20

尺寸(Size) : L140xW90mm  
可调高度(Adjustable height) : H115 / H130mm  
材质(Material) : PP



可调节高度  
Adjustable height

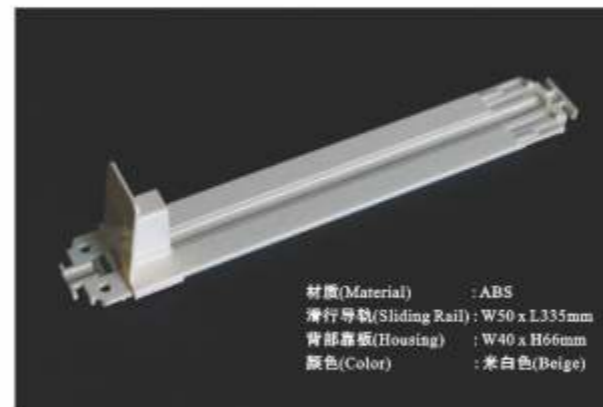

材质(Material) : ABS  
滑行导轨(Sliding Rail) : W50 x L335mm  
背部靠板(Housing) : W40 x H66mm  
颜色(Color) : 米白色(Beige)



型号(Item No.): FLD-X10

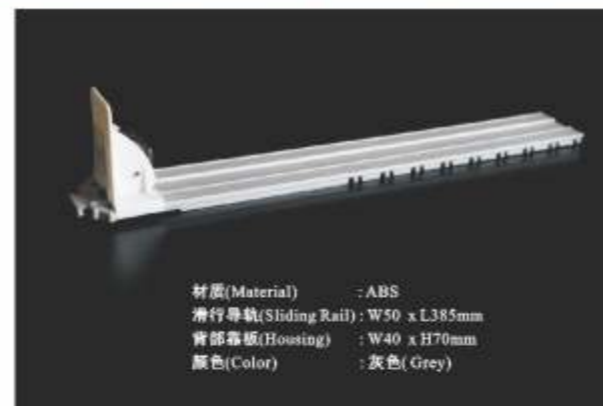

材质(Material) : ABS  
滑行导轨(Sliding Rail) : W50 x L385mm  
背部靠板(Housing) : W40 x H70mm  
颜色(Color) : 灰色(Grey)



型号(Item No.): FLD-X11



材质(Material) : PC  
滑行导轨(Sliding Rail) : W54 x L460mm  
背部靠板(Housing) : W65 x H131mm  
颜色(Color) : 透明色(Clear)



型号(Item No.): FLD-X12

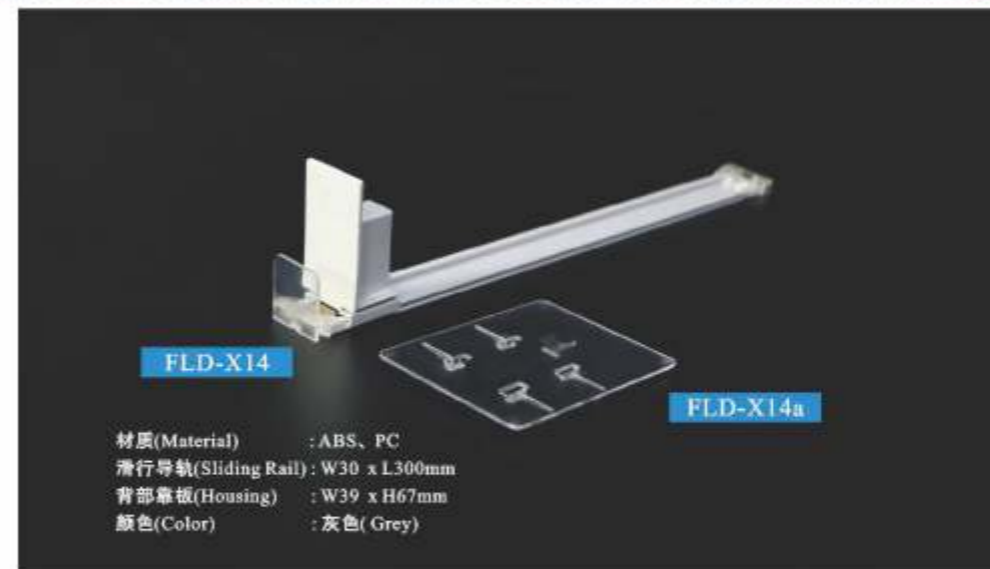

材质(Material) : ABS, PC  
滑行导轨(Sliding Rail) : W30 x L300mm  
背部靠板(Housing) : W39 x H67mm  
颜色(Color) : 灰色(Grey)

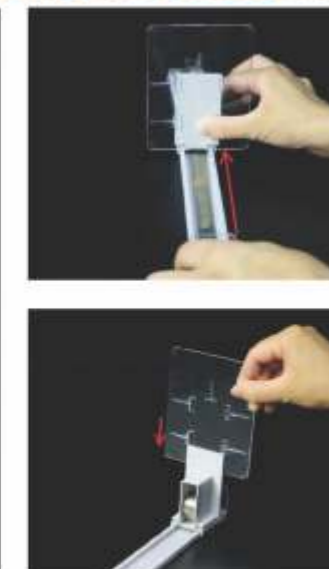

FLD-X14

FLD-X14a

推进器配件 Pusher Accessories



长度(Length): 可定制(Can be customized)  
高度(Height): 30mm  
材质(Material): PVC

型号(Item No.): FLD-X50A



长度(Length): 可定制(Can be customized)  
高度(Height): 13mm  
材质(Material): PVC

型号(Item No.): FLD-X50B

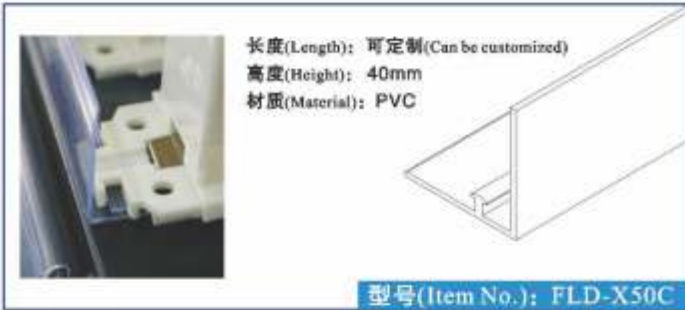

长度(Length): 可定制(Can be customized)  
高度(Height): 40mm  
材质(Material): PVC

型号(Item No.): FLD-X50C

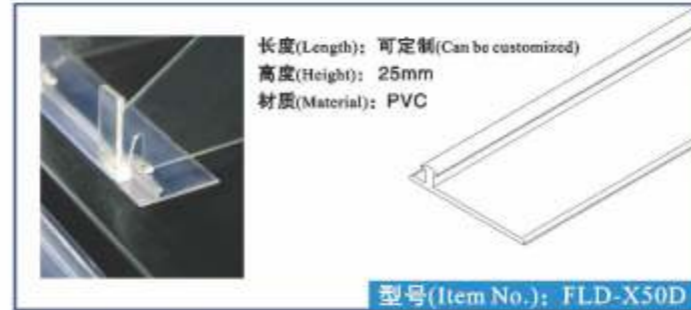

长度(Length): 可定制(Can be customized)  
高度(Height): 25mm  
材质(Material): PVC

型号(Item No.): FLD-X50D

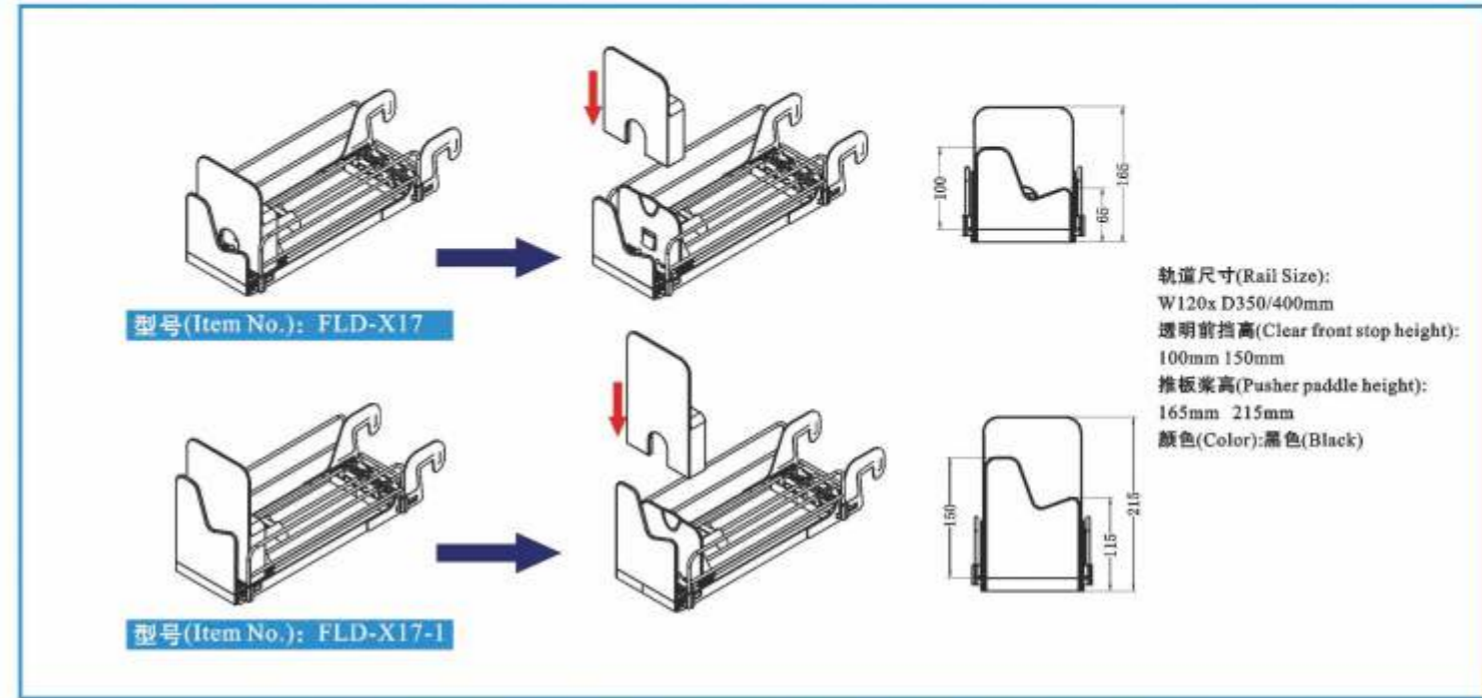

型号(Item No.): FLD-X17

型号(Item No.): FLD-X17-1

轨道尺寸(Rail Size): W120x D350/400mm  
透明前挡高(Clear front stop height): 100mm 150mm  
推板桨高(Pusher paddle height): 165mm 215mm  
颜色(Color): 黑色(Black)

单栏推进器 • Single lane product pusher

双栏推进器 • Duallane lane product pusher



悬挂式 Hanging

型号(Item No.): FLD-X15



悬挂式 Hanging

型号(Item No.): FLD-X15-1

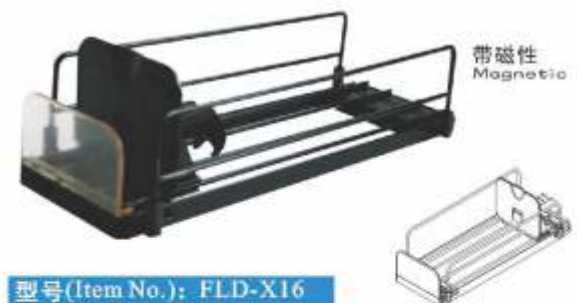

带磁性 Magnetic

型号(Item No.): FLD-X16



带磁性 Magnetic

型号(Item No.): FLD-X16-1

轨道尺寸(Rail Size): W120x D350/400mm  
透明前挡高(Clear front stop height): 60mm  
推板桨高(Pusher paddle height): 88mm  
颜色(Color): 黑色(Black)



分隔板  
Shelf Dividers

分隔板  
Shelf Dividers

# 百货、商场展示系列

IN-STORE DISPLAYS

本此列产品用于大型商场专柜及大型高档商品的产品信息及价格信息的传递，创造迷人的专场、凸显商品的工艺水准和精致。

It is used of the transmission of products and price information in the major shopping Mall.To create charming stores and highlight the commodity craft level.



- 商场多功能桌架 Multi-function Table Stand For Store
- 仓储笼 Dump Bin Basket
- 商用展示货架 Commercial Display Rack
- 百货、商场POP立牌 Marketing Stands
- 亚克力价签 Acryl Price Holders
- 衣裤架 Clothes Rack
- 收银灯、导向牌 Cashier Stands, Guide Boards
- 模特服装价格牌 Price Tags

多功能水平桌 Multi-level Table

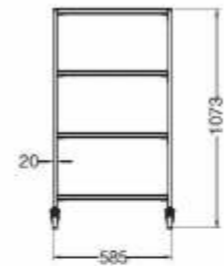
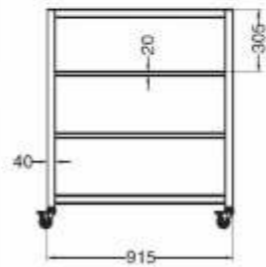

注:1.架子采用20X40方管。  
2.中间采用20mm厚的木板。  
3.木板与架子采用配件, 自攻螺丝固定。  
4.底部采用3寸, 螺杆轮子。

1. Square Tube 20x40mm.  
2. Thickness of wood boards 20mm.  
3. Using accessories and self-tapping Screw to fix boards and shelf.  
4. 3 inch screw caster.

型号 (Item No.): MT10

鞋架 Shoe bench



1. 架子采用20X40方管。  
2. 木板厚度15mm。  
Note: 1. Stand using 20x40mm square tube.  
2. Using 15mm thickness wood board.

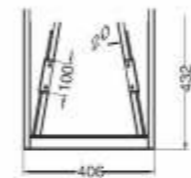
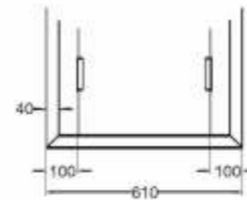

型号 (Item No.): MT11

嵌套展示桌套装 Nesting Display Table Set

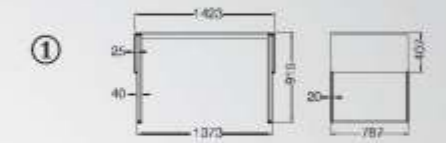

1. 架子采用20X40方管。  
2. 木板厚度25mm。

Note: 1. Stand using 20x40mm square tube.  
2. Using 25mm thickness wood board.



1. 架子采用20X40方管。  
2. 木板厚度25mm。

Note: 1. Stand using 20x40mm square tube.  
2. Using 25mm thickness wood board.

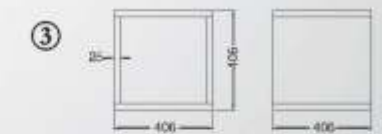

木板厚度25mm  
Using 25mm thickness wood board.

型号 (Item No.): MT12

多功能使用桌 Multi-use Table

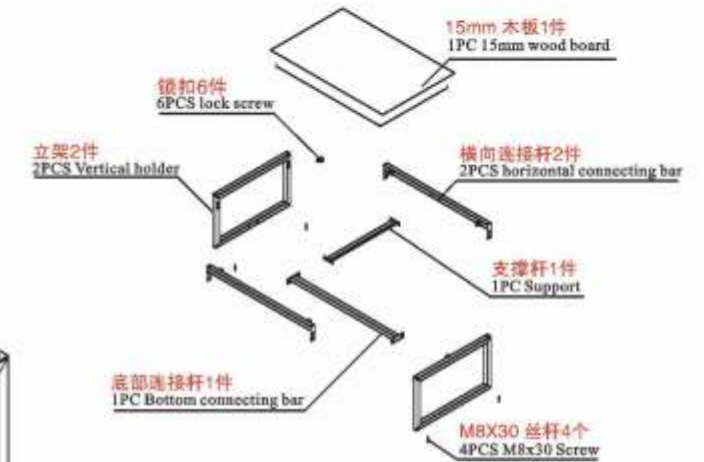
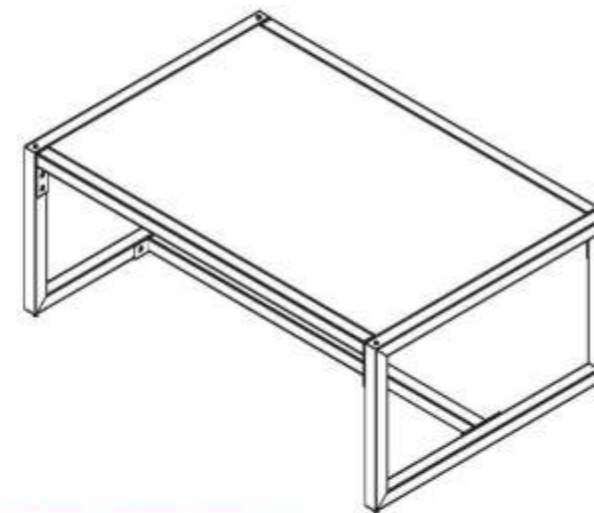

1. 铁件部分喷塑白色。  
2. 上面放置15mm厚的木板, 木板表面贴纸(仿塑木)。木板底板采用M6 x 12自攻螺丝, 数量6颗。  
3. 整体采用可拆卸方式, 连接部位采用M8铆钉和十字M8 x 25mm螺丝固定, 数量各16颗。  
4. 底部采用M8 x 30mm丝杆, 数量4颗。  
5. 架子整体可叠加, 最底下采用M8塑料脚垫, 数量4个。

1. Iron parts powder coating white color.  
2. Put the 15mm wood board on the top. The board covers wings of wood on its surface. Use 6pcs M6x12 screws on its bottom. Quantity: 6pcs.  
3. The whole table can be detachable. It fixed with M8 rivets and M8x25mm cross screw totally 16pcs.  
4. 4pcs M8x30mm screws on the bottom.  
5. The whole table can be superimposed with 4pcs M8 plastic foot pads.

型号 (Item No.): MT15

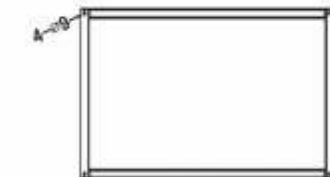
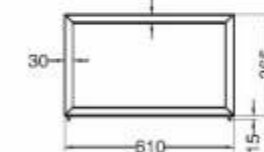
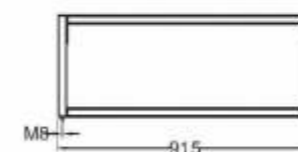

商用多功能桌架  
Multi-function Table Stand For Store

商用多功能桌架  
Multi-function Table Stand For Store

**仓储笼** 具有存放物品容量固定、堆放整洁、存放一目了然、便于库存清点等优点，同时也提高了仓储空间的有效利用率。此外，该产品坚固耐用、运输便捷、能重复使用，能有效降低仓储企业的人力消耗及包装成本。此产品不仅可以用于工厂生产车间，而且可以用于超市作为展示促销和仓储，带轮子的仓储笼可方便快捷周转。

**Dump Bin Basket**

It has the advantage of a fixed storage capacity of goods, storage at a glance, easy inventory of goods, etc., and also improve the effective utilization of storage space. In addition, the dump bin durable, easy to transport, can be reused and reduce the labor wastage and packing costs effectively. The dump bin not only can be used in the factory production workshop, but also can be used for supermarket display promotion and warehousing. Wheeled dump bin can fast and convenient turnover in the workshop.

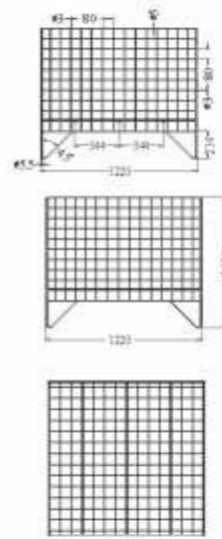
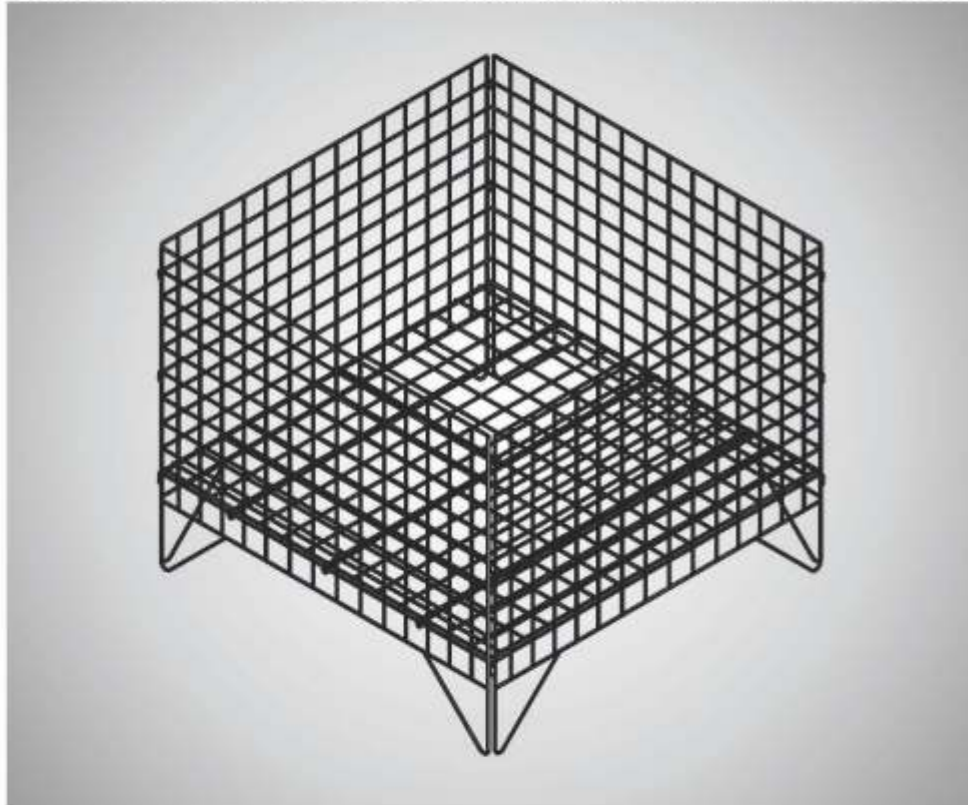

**型号(Item No.): FLD-DB10**

尺寸(Size): 1220mm x 1220mm x 1016mm  
 表面处理(Size): 镀锌、喷塑(Galvanized, Power Coated)  
 材质(Material): 铁线(Iron Wire)

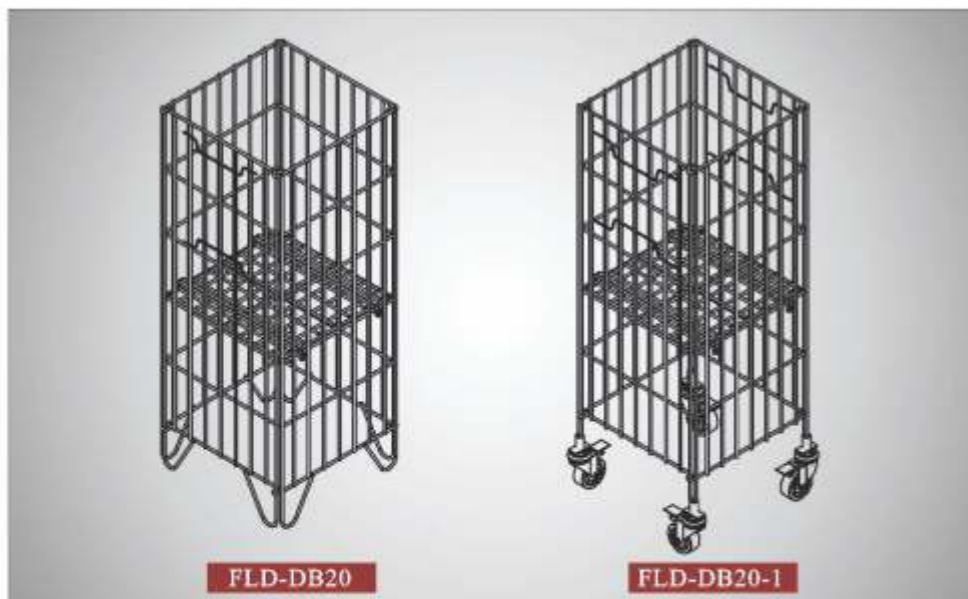

**FLD-DB20**

**FLD-DB20-1**



尺寸(Size): 305mm x 305mm x 813mm  
 表面处理(Size): 镀锌、喷塑(Galvanized, Power Coated)  
 材质(Material): 铁线(Iron Wire)

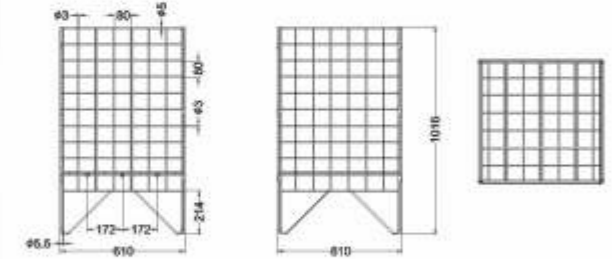
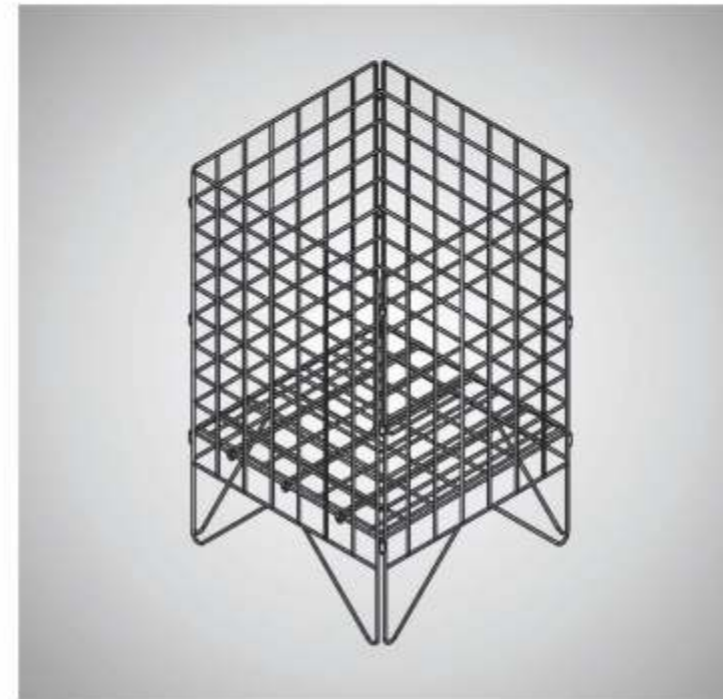

**型号(Item No.): FLD-DB30**

尺寸(Size): 610mm x 610mm x 1016mm  
 表面处理(Size): 镀锌、喷塑(Galvanized, Power Coated)  
 材质(Material): 铁线(Iron Wire)

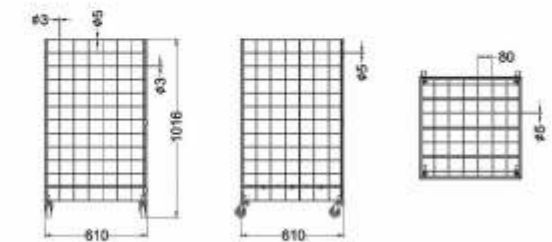
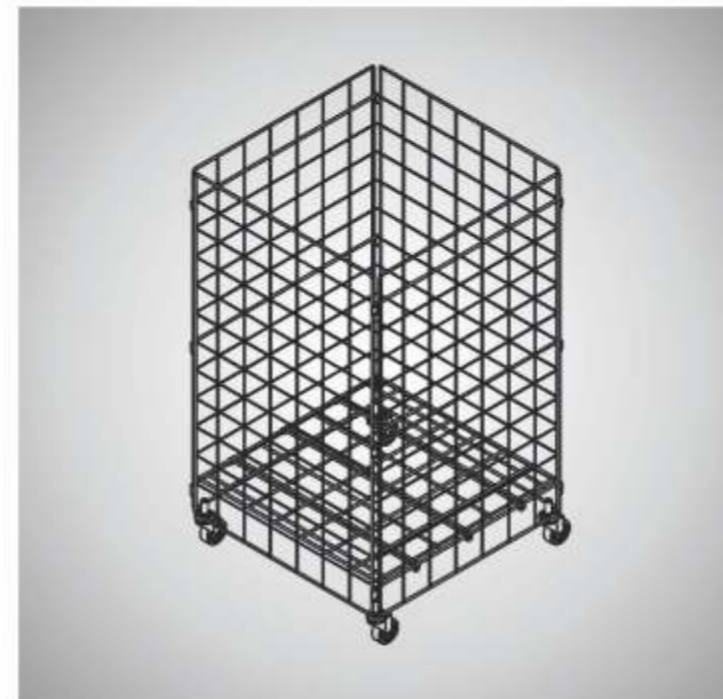

**型号(Item No.): FLD-DB30-1**

尺寸(Size): 610mm x 610mm x 1016mm  
 表面处理(Size): 镀锌、喷塑(Galvanized, Power Coated)  
 材质(Material): 铁线(Iron Wire)  
 带轮子 (With Wheel)



可折叠  
Foldable



可调节  
Adjustable

商品展架

商品展架都配有组装配件的标准体系，也可根据客户的要求定制，将这些组装配件与其他装配配件组合在一起。我们尽量让大部分展架做成扁平形状，这样就可以轻松地移动它们。

Merchandising Stands

Our wide range of Merchandising Stands comprise of standard system that comes with modular parts; semi-customisation that combine some from those modular parts with other fabricated ones according to each retailer's requirement. We try to make most of these stands flat packed, so that it is easy for the retailers to move them around the stores and also bring them along for trade shows.

多功能展示架 • Multi-Function Display Stand

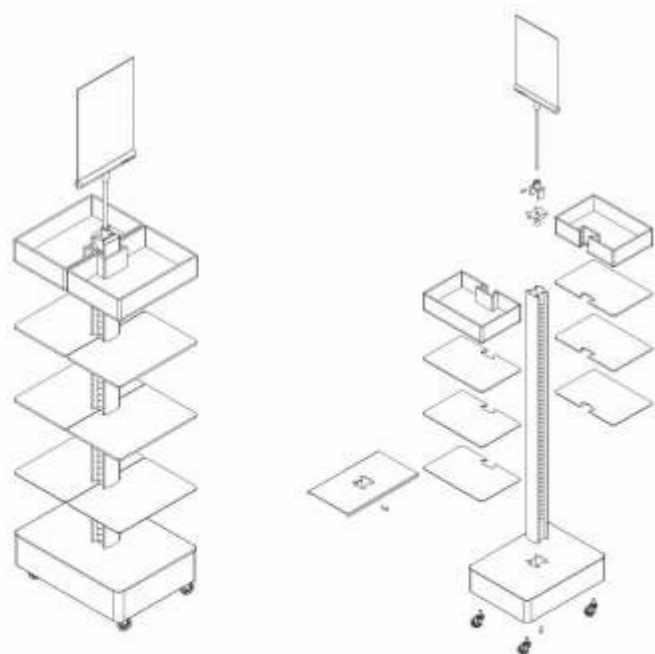

型号(Item No.): FLD-SJ1  
高度(Height) : 1650mm

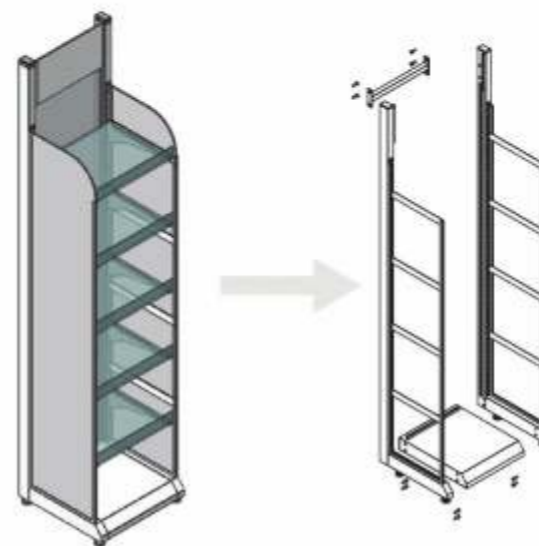

侧堆头

适用在拥挤的地面上展示商品，因为产品本身瘦长，所以可轻松地适用于商店的任何地方。可以根据品牌来互换侧面板和标题板。货架是由钢结构和耐用的注塑PET材料制成。货架可以调节的角度接近90度和75度。

Side Stacker

Can be used as cross merchandising display on crowded floors. Easy to accommodate to anywhere in the stores as it is slim. Interchangeable Side Panels and Header Board for Brands. Made of steel structure and durable injected PET Shelves. These shelves can be angled at approx. 90 and 75 degrees.

型号(Item No.): FLD-SJ3  
高度(Height) : 1500mm

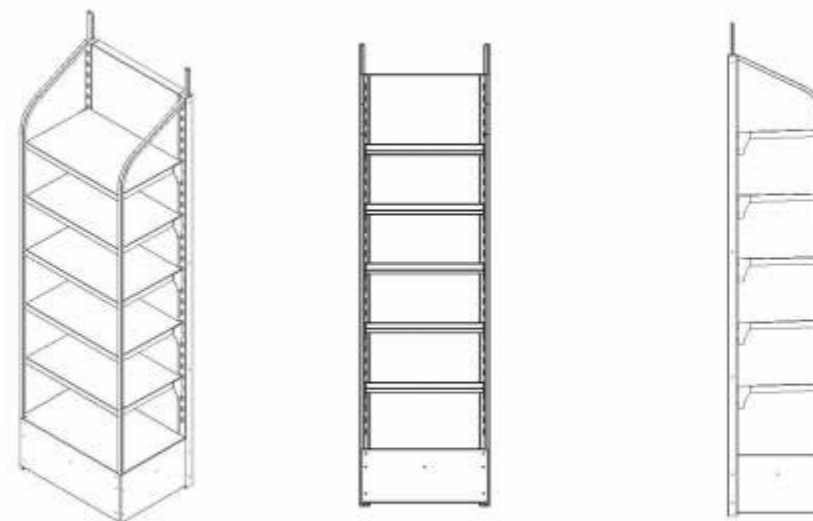

型号(Item No.): FLD-SJ4  
高度(Height) : 1450mm

雨伞架 • Umbrella Stand



分解图 Decomposition graph



型号(Item No.): FLD-SJ2  
高度(Height) : 1450mm

活动架 • Round Rack

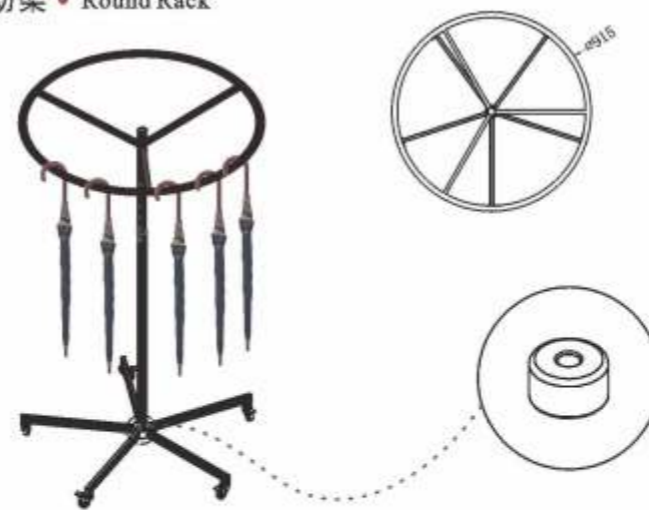

型号(Item No.): FLD-SJ5  
高度(Height) : 1524mm

商用展示货架  
Commercial Display Rack

商用展示货架  
Commercial Display Rack



**单管S型立牌**  
Single S Type Board



**型号(Item No.): FLD-J2**  
亚克力面板(Size of the acrylic board)  
: (A4) 297x210mm  
: (A3) 420x297mm  
高度(Height) : 1300mm  
材质(Material) : 不锈钢(Stainless Steel)  
底盘尺寸(Base Size) : 300x300x30mm

**L立牌**  
L Type Sign Board



**型号(Item No.): FLD-J3**  
亚克力面板(Size of the acrylic board)  
: 420x297x3mm  
高度(Height) : 1300mm  
材质(Material) : 铁喷漆 Powder Coated(Iron)  
底盘尺寸(Base Size) : 340x280x2mm  
铁喷漆 Powder Coated(Iron)

**单杆立牌**  
Single Pole Display Stand



**型号(Item No.): FLD-J12**  
亚克力面板(Size of the acrylic board)  
: (A4) 297x210mm  
高度(Height) : 1300mm  
管径(Tube Diameter) : 19mm  
底盘直径(Base Diameter) : 280mm



You can swing the image you want as you like.

**型号(Item No.): FLD-J15**  
铁框(Iron Frame) : A3  
高度(Height) : 1400mm 1200mm  
管径(Tube Diameter) :  $\Phi$ 12.7mm  
底盘直径(Base Diameter) :  $\Phi$ 320x 3mm

**光管可调节立牌**  
Double Pipe Adjustable Stand



**型号(Item No.): FLD-J5**  
调节高度(Adjustable Height) : 1000—1800mm  
画面调节(Picture Adjustable Size) : 200—600mm  
材质(Material) : 铁管电镀(Pole Chrome)  
底盘尺寸(Base Size) : 300x300x30mm  
不锈钢 Stainless Steel

**双管S型立牌**  
Double Pipe S Type Sign Board



**型号(Item No.): FLD-J7**  
亚克力面板(Size of the acrylic board)  
: (A3) 420x297mm  
高度(Height) : 1300mm  
材质(Material) : 铁管不锈钢(Pole Stainless Steel)  
底盘尺寸(Base Size) : 300x300x30mm  
(不锈钢 Stainless Steel)

**铁框单杆架** Frame Single Pole Stand Iron



**型号(Item No.): FLD-J16**  
铁框(Iron Frame) : A5  
高度(Height) : 900mm  
管径(Tube Diameter) :  $\Phi$ 12.7mm  
底盘直径(Base Diameter) :  $\Phi$ 200 x 3mm



**型号(Item No.): FLD-J17**  
铁框(Iron Frame) : A3 A4  
高度(Height) : 1300mm  
管径(Tube Diameter) :  $\Phi$ 12.7mm  
底盘直径(Base Diameter) :  $\Phi$ 320 x 3mm

**方管立牌**  
Square Pipe Sign Board



**型号(Item No.): FLD-J9**  
亚克力面板(Size of the acrylic board)  
: (A4) 297x210mm  
: (A3) 420x297mm  
高度(Height) : 1300mm  
材质(Material) : 铁电镀 Pole Chrome(Iron)  
底盘尺寸(Base Size) : 340x280x2mm

**方管立牌**  
Square Pipe Sign Board



**型号(Item No.): FLD-J11**  
亚克力面板(Size of the acrylic board)  
: (A3) 420x297mm  
高度(Height) : 1300mm  
材质(Material) : 15x15mm(方管 Square Pipe)  
底盘尺寸(Base Size) : 300x300x8mm  
(喷漆 Powder Coated)



可调节高度  
Height can be adjustable

放置购物袋  
Hang bags

可配框(Frame) : A3 A4  
高度(Height) : 1060mm  
底盘直径(Base Diameter) :  $\Phi$ 350mm

**型号(Item No.): FLD-J18**

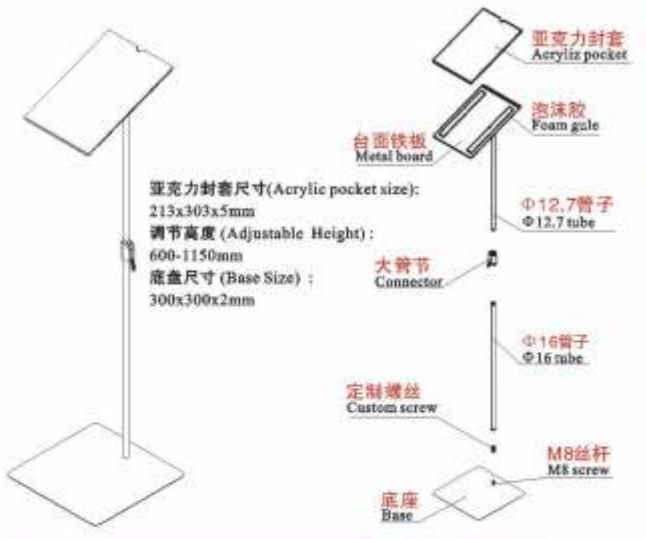

亚克力封套  
Acrylic pocket

泡沫胶  
Foam gule

台面铁板  
Metal board

亚克力封套尺寸(Acrylic pocket size):  
215x303x5mm  
调节高度(Adjustable Height):  
600-1150mm  
底盘尺寸(Base Size):  
300x300x2mm

$\Phi$ 12.7管子  
 $\Phi$ 12.7 tube

大管节  
Connector

$\Phi$ 16管子  
 $\Phi$ 16 tube

定制螺丝  
Custom screw

M8丝杆  
M8 screw

底座  
Base

**型号(Item No.): FLD-J19**

百货、商场POP立牌  
Marketing Stand

百货、商场POP立牌  
Marketing Stand

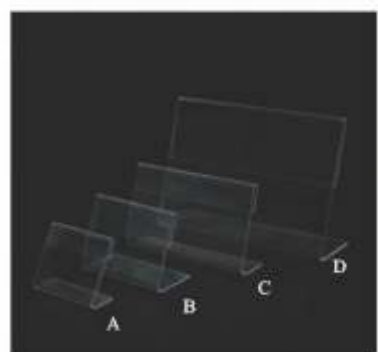

**型号(Item No.): FLD-YKL10**  
尺寸(Size): (A)60x50mm (B)75x60mm  
(C)110x65mm (D)155x105mm  
厚度(Thickness): 2mm

★ Can be customize a variety of sizes



**型号(Item No.): FLD-YKL11**  
尺寸(Size): 80x40x50mm  
厚度(Thickness): 2mm

**磁性底座卡片夹**  
Magnetic Base Card Holder

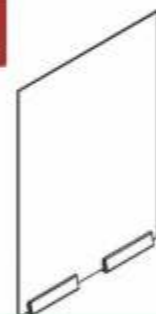

**型号(Item No.): FLD-YKL20**  
尺寸(Size): 100x22x24mm  
颜色(Color): 透明(Transparent)  
材质(Material): ABS

**亚克力货架卡件**  
Acrylic Shelf Card Holder

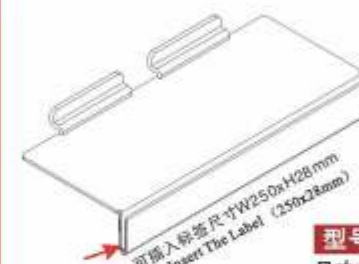

**型号(Item No.): FLD-YKL21**  
尺寸(Size): 250x100x33mm  
亚克力厚度(The Acryl Thickness): 2mm

可插入标签尺寸W250xH28mm  
Can Insert The Label (250x28mm)



**型号(Item No.): FLD-YKL12**  
尺寸(Size): 297x210mm  
厚度(Thickness): 2mm



**型号(Item No.): FLD-YKL13**  
尺寸(Size): (A)210x148mm  
(B)297x210mm  
厚度(Thickness): 2mm  
底座厚(The Base Thickness): 18-20mm



**内裤架 Underware hanger**



**型号(Item No.): FLD-YKJ8**  
尺寸(Size): 165x100mm

**拖鞋挂钩 Slippers hook**



**型号(Item No.): FLD-YKJ9**  
尺寸(Size): 165x85mm



**型号(Item No.): FLD-YKL14**  
尺寸(Size): 210x148mm  
厚度(Thickness): 10mm



**型号(Item No.): FLD-YKL15**  
底板(Material of board): 不锈钢(Stainless steel)  
亚克力尺寸(The Acryl Size): 100x150mm  
亚克力厚度(The Acryl Thickness): 3mm

**文胸架 Bra hanger**



**型号(Item No.): FLD-YKJ10**  
尺寸(Size): 260x130mm

**大毛巾架 Big towel hanger**



**型号(Item No.): FLD-YKJ11**  
尺寸(Size): 375x97mm

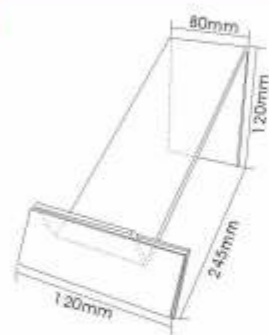

**型号(Item No.): FLD-YKL18**  
尺寸(Size): 可定制(Can be Customized)  
厚度(Thickness): 3mm



**型号(Item No.): FLD-YKL19**  
尺寸(Size): 可定制(Can be Customized)  
厚度(Thickness): 3mm

**小毛巾架 Small towel hanger**



**型号(Item No.): FLD-YKJ12**  
尺寸(Size): 225x90mm



衣架架  
Clothes Rack



超市收银灯  
Supermarket Cashier Lamp



型号(Item No.): FLD-J20  
直径(Diameter): 350mm

Using Various Geometric Shape Of Identifions To Help Customer Indicate The Direction,Improve Stores and Class Taste.



三角收银箱  
Triangle cashier box



型号(Item No.): FLD-J21

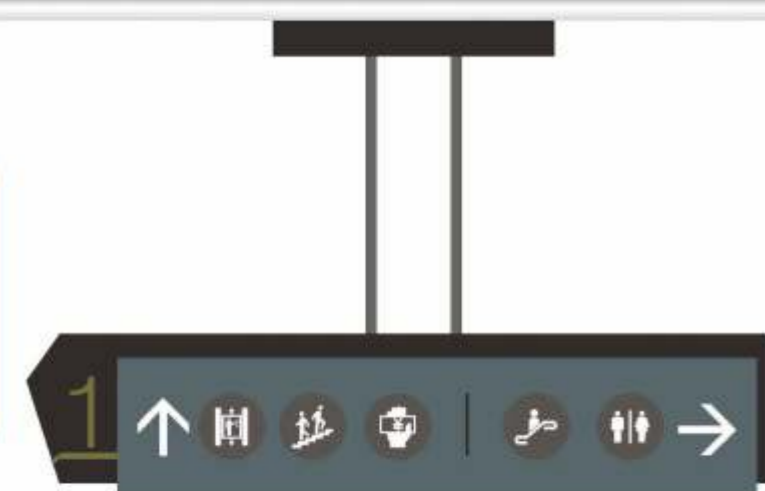

指向牌  
Guide Post

型号(Item No.): FLD-J22



天地柱  
Post

型号(Item No.): FLD-J23



型号 (Item No.): FLD-F1

材质 (Material)	单个数字尺寸 (Single figure size)	内容 (Content)	颜色 (Color)
强磁 Strong magnet	WxH12mm	一盒16组文字16条 品名9条 16 pieces letters 9 item names	黑底金 黑底白 Black with golden figure, Black with white figure

型号 (Item No.): FLD-F2

材质 (Material)	单个数字尺寸 (Single figure size)	内容 (Content)	颜色 (Color)
铝合金底座 Aluminum base	WxH12mm	一盒16组文字16条 品名9条 16 sets per box, 16 pieces letters 9 item names	黑底金 黑底白 Black with golden figure, Black with white figure

型号 (Item No.): FLD-F4

单个数字尺寸 (Single Figure Size)	颜色 (Color)	
A:4x6mm	黑底金 黑底白 黑底银 Black with golden figure, Black with white figure, Black with silver figure	五角凸字 Pentagon raised figure
B:6x9mm		
C:11x15mm		

型号 (Item No.): FLD-F6

单个数字尺寸 (Single Figure Size)	颜色 (Color)	
A:4x6mm	黑底金 黑底白 Black with golden figure, Black with white figure	五角平字 字体印刷 Pentagon flat figure with printing figure
B:6x9mm		
C:11x15mm		

型号 (Item No.): FLD-F7

品名 (Commodity)	总高 (Total height)	材质 (Material)	
橱窗模特标价牌 The fashion model tag	580mm	铝合金 Aluminum	四联 4 layers

型号 (Item No.): FLD-F8

宽 (Width)	高 (Height)	材质 (Material)	
120mm	170mm	铝合金 Aluminum	六联 6 layers

模特服装价格牌  
Price Tags

POSTER HANGGER SERIES  
**悬挂系列**



本系列产品可以随意组合，循环使用，产品操作简约易用，让您悬挂轻松自如。加强商品信息的引导，让您的卖场空间变得井井有条。

It is assembled freely and used circularly, operated simply and hung easily. In this way, it makes your store methodically, strengthen the guidance of commodity information and promote them.



- 铝合金海报框 Aluminum Snap Frame
- 铝合金悬挂系统 Aluminum Poster Hangers
- 海报杆 Poster Profiles



型号 (Item No.): FLD-R10

原材料(Material): 阳极氧化铝(Anodized Aluminum)  
 画面尺寸(Graphic Size): A0/A1/A2  
 常规色(Regular Color): 银色、黑色(Silver, Black)  
 \*尺寸和颜色可定制(Size and color can be customized)

画面尺寸 Graphic Size	毛重 G.W.(kg)	包装规格 Packing Specification
A0	13.5	1pcs/ctn(910x100x550mm)
A1	7.8	1pcs/ctn(660x90x1210mm)
A2	4.7	1pcs/ctn(510x90x910mm)

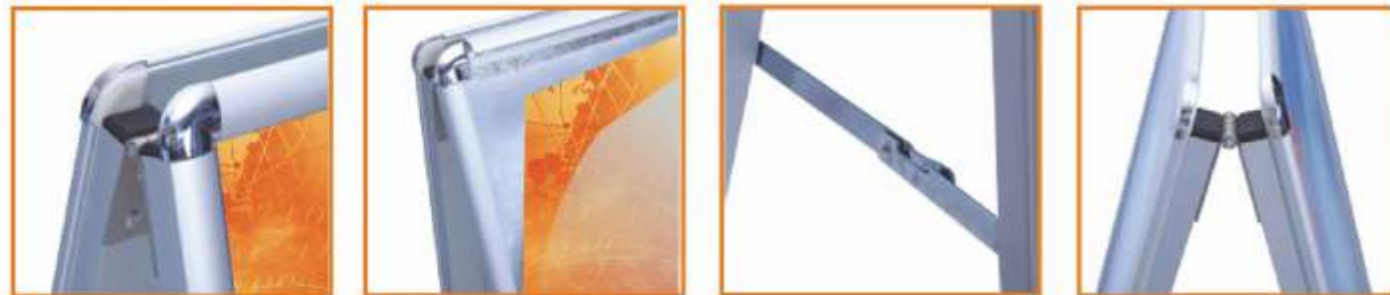

画面尺寸 Graphic Size	毛重 G.W.(kg)	包装规格 Packing Specification
A0	19.4	5pcs/ctn(900x100x1240mm)
A1	19.3	10pcs/ctn(650x210x900mm)
A2	11.7	10pcs/ctn(480x210x650mm)
A3	7.0	10pcs/ctn(350x210x480mm)
A4	4.6	10pcs/ctn(260x210x350mm)

型号 (Item No.): FLD-R11

原材料(Material): 阳极氧化铝(Anodized Aluminum)  
 画面尺寸(Graphic Size): A0/A1/A2/A3/A4  
 常规色(Regular Color): 银色、黑色(Silver, Black)  
 \*尺寸和颜色可定制(Size and color can be customized)

画面尺寸 Graphic Size	毛重 G.W.(kg)	包装规格 Packing Specification
A3	2.8	1 set/ctn(420x70x750mm)
A4	2.5	1 set/ctn(350x70x750mm)



型号 (Item No.): FLD-R12

材质(Material): 铝合金框+不锈钢杆&底座  
 (Aluminum Snap Frame+Steel Pole&Base)  
 展架高度(Display Height): 650—1050mm  
 画面尺寸(Graphic Size): A3/A4  
 \*常规色(Regular Color): 银色、黑色、金色(Silver, Black, Gold)  
 尺寸和颜色可定制(Size and color can be customized)



铝合金海报框  
Aluminum Snap Frame

铝合金轨道 • Aluminum Track



型号 (Item No.): FLD-R13  
 宽度(Width) : 15mm  
 高度(Height) : 30mm  
 材质(Material) : 铝合金(Aluminum Alloy)



FLD-R13-2

封头 End Cap



FLD-R13-3

一字连接件 One Connector



FLD-R13-4

直角连接件 L Connector



FLD-R13-5

T型连接件 T Connector

悬挂条 • Hanging Strip



型号 (Item No.): FLD-R15-1  
 宽度(Width) : 22mm  
 材质(Material) : PP



型号 (Item No.): FLD-R15  
 宽度(Width) : 20mm  
 高度(Height) : 30mm  
 材质(Material) : 铝合金(Aluminum Alloy)



FLD-R15-2

一字连接件 One Connector



FLD-R15-3

封头 End Cap



FLD-R15-4

直角连接件 L Connector



FLD-R15-5

T型连接件 T Connector



FLD-R15-13

塑料挂钩 Plastic Hook



FLD-R13 通用配件  
 FLD-R15 General Accessories



FLD-R13-6

升降扣组合 Extend & Fall Adjustable Button



FLD-R13-7

膨胀挂钩 Expand Hook



FLD-R13-8

滑动环 Slip Ring



FLD-R13-9

钢丝扣 Steel Wire Button



FLD-R13-10

塑料S钩 S Hook



FLD-R13-11

挂绳组合 Hanging Rope Combination



FLD-R13-12

钢丝绳 Steel Wire Line

大部分国内超市悬挂系统都存在问题，  
 不过铝合金轨道系列可以很好的解决这个问题，  
 它们能随意组装，重复使用，并且完美的悬挂产品。

Most domestic supermarkets exist a problem of suspension,  
 but Aluminum alloy orbit series can help you solve this problem,  
 it can assemble at will and repeat use, haning products in a perfect way.

H:37mm



FLD-P10

Z型钩 Z Type Hook



Φ15mm Φ20mm Φ25mm Φ30mm Φ40mm

FLD-P11

金属卡圈 Circle Metal Clip

H:50mm 70mm



FLD-P12

金属S型钩 Metal S Hook



FLD-P13

塑料扎带 Plastic Bandage



FLD-P14

塑料扎扣 Plastic Joint



滚轴海报杆  
Roller Poster



型号(Item No.): FLD-N6

宽度(Width) : 14mm  
高度(Height) : 25mm  
材质(Material) : 铝合金(Aluminum)  
滚轴材质(Roller Material) : PVC



Installation is simple and convenient



塑料海报杆 • Plastic poster



型号(Item No.): FLD-N5

直径(Diameter) :  $\Phi 15$ mm  
材质(Material) : 塑料(Plastic)

软硬夹海报杆 • Soft and hard clip poster



型号(Item No.): FLD-N7

高度(Height) : 20mm  
材质(Material) : PVC



透明塑料海报杆  
Transparent Plastic Poster Pole



型号(Item No.): FLD-N8

颜色(Colour) : 透明(Transparent)  
材质(Material) : PVC



www.fldpop.com

# 杭州富临德

## 与您一起携手共创未来

Hangzhou Fulinde Displays Manufacturer

hope to work together with you to create the future

让客户得到更多的**服务**

更多的**价值**

*It's our responsibility to*

*provide the best services for you!*

